

NEW

BOOK OF

AIRCRAFT

**SOAR UP INTO THE SKIES AND
DISCOVER THE FUTURE OF FLYING**

50+
**ICONIC PLANES &
HELICOPTERS**



FROM THE
MAKERS OF
**HOW IT
WORKS**

Centennial Specials/a360media Specials A



Display until 8/5/24 U.S. \$13.99 / CAN \$16.99

- ☆ **COMMERCIAL**
- ☆ **MILITARY**
- ☆ **HYPERSONIC**
- ☆ **& MORE**



Or go to:
www.magazineshop.us/amelia

FREE SHIPPING
on all U.S. orders

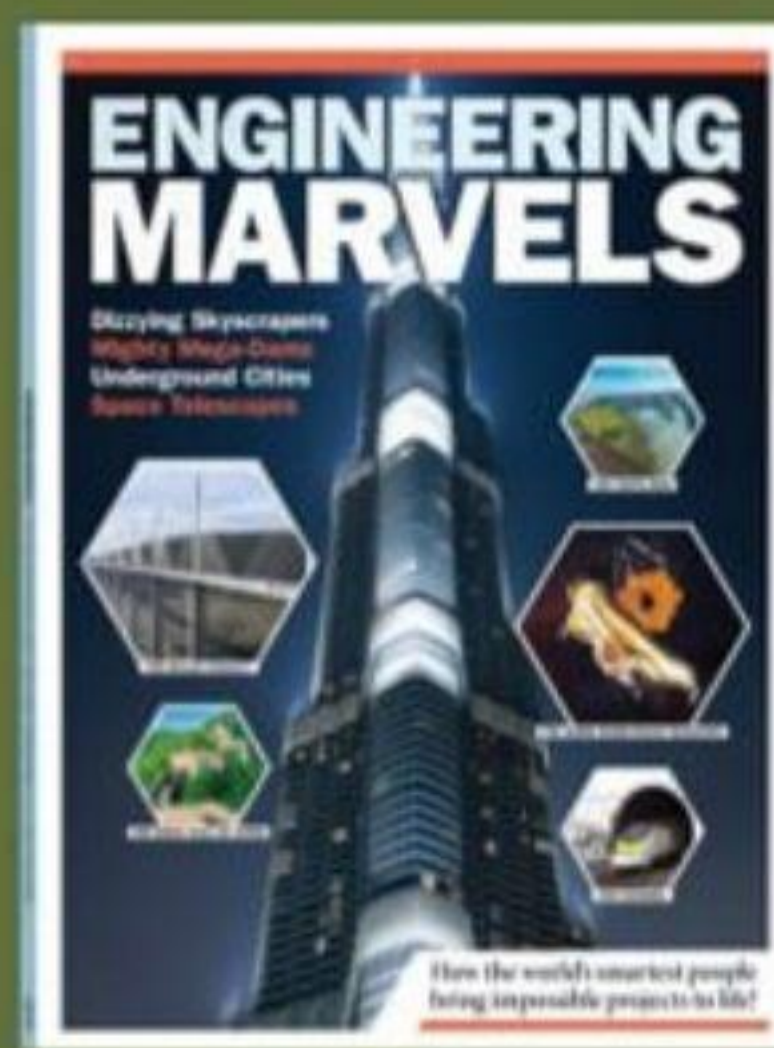
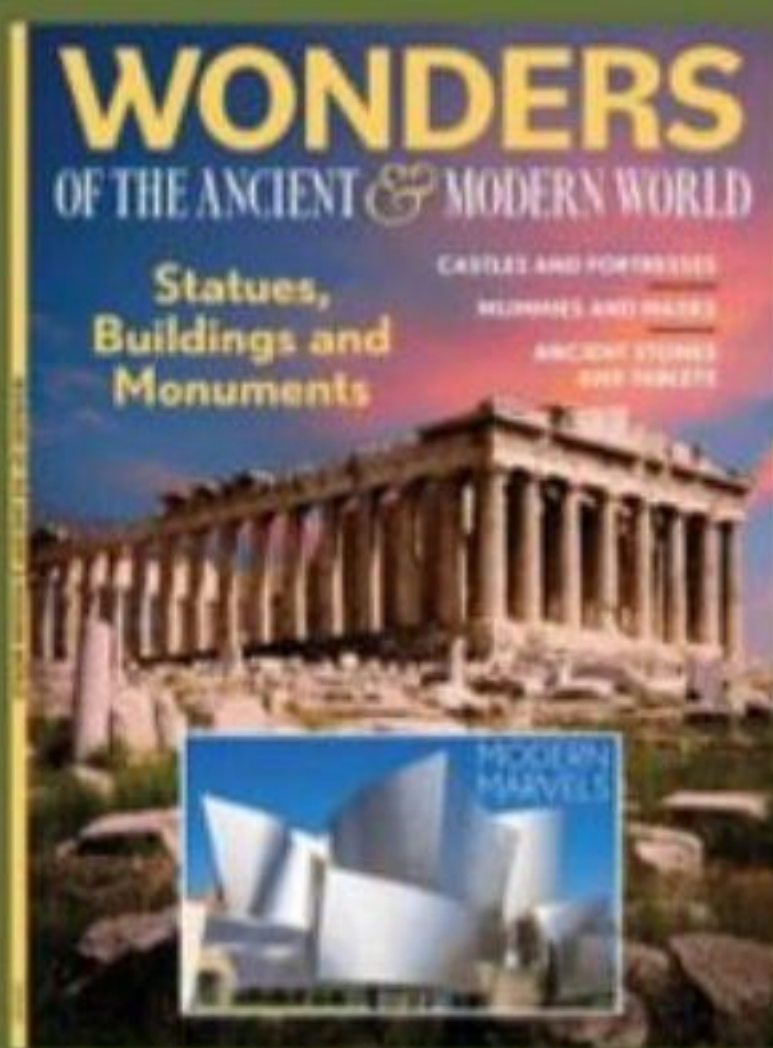
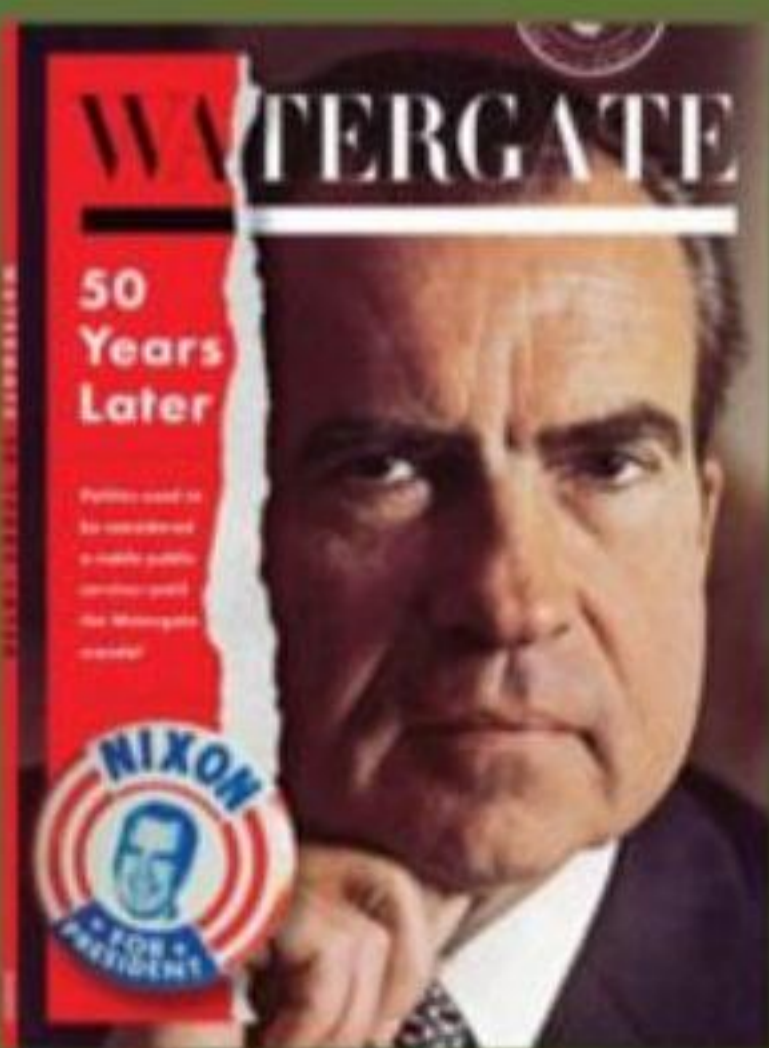

Find these magazines and many more online!

Welcome to

BOOK OF

AIRCRAFT

The history of human aviation spans over a hundred years, from the first manned flight of the Wright Flyer in 1903, which flew a ground-breaking 853 feet, to the futuristic hypersonic planes that look set to revolutionize travel. Today's aircraft are constantly evolving and being upgraded; would the Wright brothers even recognize a Eurofighter Typhoon as a descendant of their Flyer? In this new edition of How It Works Book of Aircraft, we will bring to life a plethora of modern flying machines. Find out what it takes to become a pilot for the Red Arrows and how the Supermarine Spitfire became such a successful weapon of war. Discover how commercial airliners are becoming more and more efficient and the many ways in which drones are reshaping everything from making movies to saving lives. Enjoy the book!



HOW IT WORKS BOOK OF AIRCRAFT

CONTENTS



ICONIC AIRCRAFT

006 The world's most iconic aircraft



MILITARY AIRCRAFT

022 F-35 and future fighters

028 Aerobatic displays

036 100 years of fighter planes

044 Supermarine Spitfire

046 Lancaster Bomber

048 Sea Harrier

050 Sea Vixen

052 Westland Lynx

054 Strategic bombers

058 Attack helicopters



COMMERCIAL AIRCRAFT

068 Commercial drones

074 How to build a plane

078 The luxury of the Lineage 100 jet

080 World's largest passenger jet

082 Solar-powered aircraft

084 Inside a cargo plane

086 Boeing 787 Dreamliner

090 Hypersonic flight



28
Aerobatic displays



80
The largest
passenger jet



52
The record-
breaking helicopter



90
5 times the
speed of sound



HOW IT WORKS ICONIC AIRCRAFT

12 most iconic aircraft



From the early days of aviation all the way through to the modern



DID YOU KNOW? The Wright brothers' father, a church minister, was adamant human flight could not be achieved



FIGHTING A
WORLD WAR

THE ULTIMATE
MILITARY MACHINE

AIRCRAFT

day, iconic aircraft of all shapes and sizes have taken to the skies





HOW IT
WORKS

ICONIC AIRCRAFT

12 most iconic aircraft

Wright Flyer

The iconic aircraft that was created by the most famous of sibling partnerships



Orville and Wilbur Wright were dedicated to their task of developing powered flight. Meticulously tested, the Wright Flyer was constructed in Dayton, Ohio but failed to take off on the first tests carried out on December 14, 1903. It eventually managed to get airborne a few days later on December 17 and achieved a best of 853 feet as Wilbur and Orville took turns to pilot their

invention. The aircraft was launched from a short monorail track by two modified bicycle wheel hubs. The engine was very basic and worked using a hand lever that could only open and close the fuel line rather than throttle. Prior to the Flyer, the brothers created various gliders from 1900 to 1903 that were tested without great success. Eventually, they found the perfect formula as it became the first

heavier than air machine to get airborne. Designed in a biplane structure, the Wright Flyer had an unfortunate untimely demise when it was wrecked four days after its maiden flight by a huge gust of wind. The design was first housed in the British Science Museum before moving to the Smithsonian National Air and Space Museum in the USA after Orville's death in 1948.

Construction

The aircraft was created out of spruce and ash, which were chosen for their strong yet lightweight properties. Muslin fabric was covered over the wood.

Wing warping

When developing their projects, the brothers designed a system of gears and pivoting shafts that could angle the aircraft in the desired direction.



Engine

The Flyer's power system produced 12 horsepower and was an inline piston engine created by local mechanic, Charlie Taylor.

The statistics...



Wright Flyer

Launch date: December 17, 1903

Length: 21.1ft

Weight: 605lb

Wingspan: 40.3ft

Max speed: Minimal

Max altitude: Minimal

DID YOU KNOW? The 747 was created by a team of 50,000 people including mechanics, engineers and secretaries

Boeing 747

A behemoth of the skies, the size and sheer scale of the 747 is now legendary



Giants of the sky

The 747's immense bulk means it can carry 3,400 pieces of luggage and its total wing area is larger than a basketball court.



Engine

In addition to the technology found inside the cockpit, the 747 utilizes high-bypass turbofans that make it powerful, fuel efficient and quiet.

Modern technology

As well as being a huge machine, the 747 also contains state of the art technology such as a GPS system that weighs less than a laptop.



In the 1960s, aviation companies had a problem. With the popularity of aviation soaring for business, recreation and industry, the supply of aircraft was struggling to meet demand. But Boeing had a solution up its sleeve; the biggest civilian airplane ever built, the 747. Built in less than 16 months by a group of workers known as 'the Incredibles', the design came in three variations—passenger, cargo and passenger/freighter—and was first flown in 1968. By 1970, this new breed of jumbo jet had fitted seamlessly into the world's air traffic and silenced

critics. Since its inception, the 747s have appeared in a variety of models. The 747-400 was first flown in 1988 and is a combination of the earlier freight and passenger models. It is the bestselling model.

As of January 2023, the 1,574 models of the 747 that had been built had flown over 4 billion passengers. While no longer in production and long since surpassed in size by newer jumbo jets such as the Airbus A380, the 747 remains an icon, one that will always be remembered as the plane that proved giant passenger aircraft would change travel forever.

The statistics...



Boeing 747-400

Launch date: 1988

Length: 231ft

Weight: 399,000lb

Wingspan: 211.5ft

Max speed: 614mph

Max range: 8,357mi

Years in service: 1988-present



HOW IT
WORKS

ICONIC AIRCRAFT

12 most iconic aircraft

Stealth Bomber

Virtually invisible to radar, the Stealth Bomber is a scientific vision turned reality



Commonly known as the Stealth Bomber, the Northrop Grumman B-2 Spirit is a ground-breaking piece of aviation. The design was a giant leap forward in aviation technology and was first flown on July 17, 1989, before joining the US Air Force's operational fleet in 1993. Four 19,000-pound thrust F118-GE engines allow the B-2 to cruise at high subsonic speeds and was, at its peak, the largest military programme at Boeing with

10,000 people employed on the project. The engine is so state of the art that it uses a temperature control system to minimize the aircraft's thermal signature. A strategic, long-range heavy bomber, it only achieved full operational capacity in 2003, ten years after its introduction into the fleet. Twenty-one B-2s are now in operation and are located at the Whiteman Air Force Base in Missouri but are often transported around by a portable hangar

system. The most frightening attribute of the B-2 is its capacity to carry an immense payload. Its armament includes many types of nuclear weaponry, Mark 84 bombs, cruise missiles and a rotary rocket launcher to name but a few. A key member of the USA's long-range strike arsenal, it can fly in any weather condition and is a force to be reckoned with, especially as it is being constantly updated and improved by the US Air Force.

Stealth material

The Stealth Bomber's structure is composed of resin-impregnated graphite fibre, a reinforced polymer compound that has a radar-absorbent coating.

Payload

Designed as an advanced bomber, the B-2 can accommodate more than 40,000 pounds of a nuclear or conventional payload.

The statistics...



Northrop Grumman B-2 Spirit

Launch date: 1997
Length: 69ft
Weight: 158,071lb
Wingspan: 172ft
Max speed: 628mph
Max altitude: 49,869ft

Efficiency

Operated by a two-man crew, the Stealth Bomber's weaponry can perform the duties of 75 conventional aircraft.

"The most frightening attribute of the B-2 is its capacity to carry an immense payload"

Concorde

The world's only ever supersonic passenger aircraft is an incredible example of aviation engineering and technology



In 1971 the skies of Britain were dominated by the sound of sonic booms. These were the results of a futuristic Anglo-French project known as Concorde. After 5,000 hours worth of testing (making it the most tested aircraft of all time), it was ready. Seating 100 people, Concorde represented the next step in commercial travel. It was so fast that it still holds the record for the shortest transatlantic crossing, a blistering 2 hours 52 minutes and 59 seconds. The aircraft accomplished this by utilizing 'reheat' technology, which injects extra fuel at takeoff. This innovative

technology helped the Concorde fly around the globe in 1992, on the 500th anniversary of Christopher Columbus' historic journey. It managed to complete the journey in just under 33 hours.

The Concorde's final flight was on October 24, 2003, when it was discontinued after a series of faults that ended in disaster in 2000 when it crashed, killing 113 people. The Concorde made a total of 50,000 flights for 2.5 million passengers and despite its retirement, is still held in high regard as an icon of aviation and there are still calls to bring it back the world's only ever supersonic passenger airline back into service.

The statistics...



Concorde

Launch date: 1976

Length: 203ft

Weight: 23,400lb

Wingspan: 83.8ft

Max speed: 1,349mph

Max altitude: 60,000ft

Years in service: 27

Droop nose

An iconic image of the Concorde is its hydraulically-powered droop nose, which was shaped to reduce drag and improve aerodynamics.

Engines

Controlled by a flight crew of three, each of Concorde's astonishingly powerful engines gave the aircraft supersonic capabilities and 38,050lb worth of thrust.

Landing gear

The Concorde had ten landing wheels that help land its huge weight safely. The powerful engine was incredibly thirsty, consuming 5,638 gallons of fuel every hour!



The Enola Gay

A plane entirely famous for its atomic payload, the Enola Gay dropped one of the most destructive bombs in human history

The statistics...

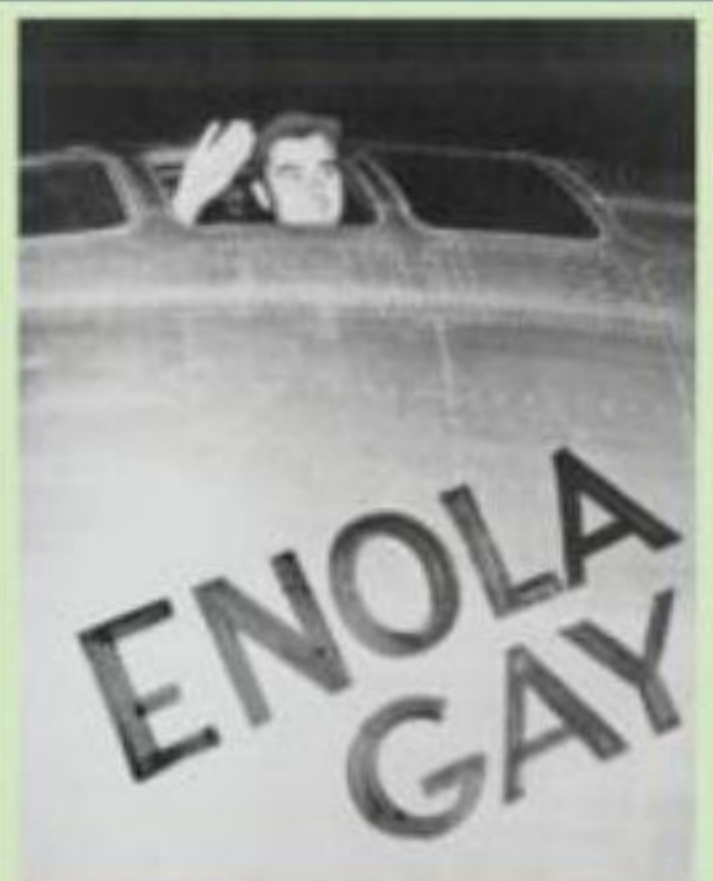

Enola Gay

- Length: 99ft
- Weight: 69,000lb
- Wingspan: 141.3ft
- Max speed: 365mph
- Max altitude: 31,850ft
- Years in service: One

Boeing built

Enola Gay was a type of Boeing B-29 Superfortress and its long range and ability to carry a huge atomic payload made it ideal for the Hiroshima mission.

Production line

Up to 4,000 B-29s were made on a rush basis in what was a huge manufacturing programme with hundreds of thousands of workers.



Little Boy

The blast that engulfed Hiroshima was equivalent to 20,000 tons of TNT and killed 80,000 people instantly, but it helped end the war.



'Enola Gay,' and 'Little Boy'. Two names that are now synonymous with changing the city of Hiroshima and the whole world forever. Named after pilot Paul W. Tibbets' mother, Enola Gay was a B-29 bomber built under the top-secret 'Silverplate' programme. Part of a batch of 15 bombers, it was chosen to fly the first ever atomic combat mission. The weapon would be known as 'Little

Boy' and was a 15-kiloton bomb. Taking off at 2.45 am local time, it arrived in Iwo Jima at 6.05 am and armed its payload. After Little Boy was dropped 11.5 miles from the detonation point, the aircraft turned to make its hasty escape. As the atomic bomb sent Hiroshima to oblivion, Enola Gay was rocked by several after shocks as it withdrew. The crew remember seeing the resulting mushroom cloud for an hour and half

afterwards as the aircraft returned to base, mission accomplished.

Unknown to many, Enola Gay actually went on a second mission later the same month to scout out the target for the second atomic bombing mission. Today it is housed in the US National Air and Space Museum but will always be remembered for that devastating day in the summer of 1945.

DID YOU KNOW? Amelia Earhart was only the 16th woman in the world to be issued a pilot's license

Lockheed M10 Electra

Often overshadowed by its infamous pilot, the Lockheed Model 10 was still an iconic aircraft

State of the art

The entire aircraft was modern, from its retractable landing gear, to wing flaps to variable pitch propellers.

Design

The Electra 10A was Lockheed's first all-aluminum aircraft and the use of this material made it stronger as the alloy shared the weight of the onboard load.

The statistics...

Lockheed Electra 10E

Length: 38.7ft

Weight: 7,100lb

Wingspan: 55ft

Max speed: 194mph



"The operation ran into trouble and Earhart and the Lockheed Model 10 disappeared"

Twin tail

The Model 10 had a signature twin tail in addition to a distinctive art deco appearance that was very popular at the time.



Built as a response to the Douglas DC-2 and the Boeing 247, Lockheed was one of the companies transforming commercial aviation in interwar USA. Twin engine, the plane was originally intended for commercial use and could accommodate ten passengers and two crew. Before being used by Earhart, Northwest Airlines flew the plane in its fleet in the late 1930s and it was also taken on by

European and Australian firms. The aircraft's most famous moment however, was undoubtedly its final journey. The plane used on the voyage was actually a modified version of the original model. More fuel tanks were added to the aircraft, increasing the carrying capacity and also the electronics were altered to add radio direction finders, which was state of the art at the time. Piloted by young pilot Amelia

Earhart, the mission was simple; fly around the world. Tragically, the operation ran into trouble and Earhart and the Lockheed Model 10 disappeared in mysterious circumstances in October 1937. The reasons are still debated to why Earhart and her navigator Fred Noonan disappeared on the final leg of their journey with reasons ranging from a lack of fuel to a crash landing.



HOW IT WORKS

ICONIC AIRCRAFT

12 most iconic aircraft



LZ 129 Hindenburg

This colossal machine is an example of a bygone era of aviation

Lift

Hydrogen was preferred to helium as it was lighter and more cost efficient but critically, it was incredibly flammable.

Propaganda tool

The Nazis were aware of the symbolic value of the Hindenburg so emblazoned it in swastikas as it appeared at the Berlin Olympics and the Nuremberg Rally.

Control car

The Hindenburg was maneuvered by the 'Führergondel' or control car on the bow of the airship. Rudders and elevator wheels helped pilot the massive machine.

The statistics...



LZ 129 Hindenburg

Launch date: March 4, 1936

Length: 803.8ft

Diameter: 135.1ft

Max speed: 84mph

Crew: 40 flight officers, 12 stewards and cooks

Years in service: One year and two months



In the first few decades of the 20th century, giant airships filled the sky. They were the preferred transport of the rich and famous and were particularly popular in Germany, where Zeppelin airships were all the rage. The Hindenburg was constructed solely for transcontinental transportation and after its maiden flight became the largest object ever to fly at a mammoth 7 million cubic feet. The airship finally got airborne after financial support by the Nazi Government and its maiden flight to the USA occurred on March 31, 1936. By the end of the year it had crossed the Atlantic 34 times carrying both passengers

and cargo. It even had an autopilot system that could keep the ship on course in stable weather conditions.

All seemed to be going well for the new technology but disaster would strike on May 6, 1937. When flying over Lakehurst, New Jersey an electrostatic discharge ignited leaking hydrogen, causing the Hindenburg to explode dramatically. Miraculously, only 35 of the 97 passenger crew died with the majority just escaping with their lives. The disaster sent shockwaves across the world and the zeppelin industry never recovered. The age of transatlantic airship travel was over before it really began.

DID YOU KNOW? The inspiration for the Fokker came after a British Sopwith aircraft crashed behind enemy lines

Fokker Dr.I

The most famous German aircraft of the Great War and the triplane of choice for the Red Baron

"The fighter remains an evocative symbol of the dogfights over the Western Front"

Firepower

The German pilots wielded twin 7.92mm Spandau LMG 08/15 machine guns that would cause mayhem to the British planes in the 1915-1916 'Fokker Scourge'.

The statistics...



Fokker Dr.I

Launch date: 1917

Length: 18.93ft

Weight: 895lb

Wingspan: 23.62ft

Max speed: 103mph

Max altitude: 19,997ft

Number produced: 320



Three wings

The Fokker was a dreidecker (three-decked) fighter, with its wheel structural support acting as a smaller fourth wing.

Engine

Alongside the wings, the rotary engine gave the Dr.I an excellent service ceiling and climbing capabilities for the era.



Remembered as one of the greatest aircraft of the First World War, the Fokker DR.I filled British and French hearts with dread. Powerful and highly maneuverable, opposing pilots quickly learnt that it was not to be taken lightly, especially when it was being piloted by Manfred von Richthofen, the German fighter ace nicknamed 'the Red

Baron'. As the war progressed, the triplane was hampered by structural issues and only 320 were produced. It could only last for a total of 80 minutes in the air on one tank of fuel and they were grounded completely for a period in the winter of 1917 when the wing attachment points were considered far too weak when in flight. Part of the Jagdgeschwader 1 fighter unit, the

Dr.I returned to the skies in the spring of 1918 but was only ever truly effective in the hands of skilled pilots, so never made it as the main aircraft in the German air force, the Luftstreitkräfte. However, the fighter remains an evocative symbol of the dogfights over the Western Front and the bright red edition piloted by the formidable Red Baron.



Apache Helicopter

Destructive on land, sea and air, the Apache isn't far off being the ultimate military machine



A nightmare for tanks and ground troops alike, the Apache has revolutionized modern warfare. An immensely powerful war machine, the Apache is feared across the globe and can spring into action at any time, day or night, rain or shine. The AH-64 is a stalwart of the US and British militaries and has been used with great success in Iraq, Afghanistan and Kosovo. The Gulf War

in particular saw the Apache come into its own, with the Iraqi tanks no match for a combined AH-64 and F-117 Nighthawk stealth fighter assault. The gunship is effective on land, sea and air and is able to quickly respond to any skirmish, making it an ideal rapid response unit that can lead counterattacks. The design has proved so popular that it has been developed and improved on in various other

models that can be used in almost any terrain. It has also caught the attention of a number of other militaries around the world with Israel, Greece, Japan and the Netherlands all incorporating Apaches into their ranks. Boeing (known as MacDonnell Douglas at the time of the first Apache) was given a \$247-million contract in 2010 to build even more of these beasts for use in global peacekeeping.

The statistics...



Boeing AH-64 Apache

Launch date: 1984

Length: 58.17ft

Weight: 15,075lb

Max speed: 173mph

Years in service: 39

Cockpit

Two pilots control the war machine, which has a state-of-the-art cockpit complete with long-range communication and navigation systems.

Engine

Requiring expert maneuverability to dodge enemy fire and take down insurgents, the Apache has that in abundance thanks to its T700 Turboshaft engine.

Weaponry

The Apache's awesome arsenal packs a punch and is made up of Hellfire laser-designated missiles, a M230 chain gun and hydra rockets.



DID YOU KNOW? The USAF had a lot of faith in the Bell X-1—there was no ejector seat for the pilot!

Bell X-1

The first plane to go supersonic, the Bell X-1 smashed the sound barrier in 1947

Rocket launch

To enable the Bell to reach its target speed and for safety reasons, the aircraft was only ever air launched from Boeing B-29 or B-50.

"The design was so good that the X-1 provided inspiration for the space programme"

Material

The X-1 was built with high-strength aluminium and radium paint in an international orange paint scheme.

Need for speed

Cabin pressurisation, retractable landing gear and 12 nitrogen fuel spheres gave the X-1 the best chance of achieving its goal.

The statistics...



Bell X-1

Launch date: 1946

Length: 31ft

Weight: 8,100lb

Wingspan: 28ft

Max speed: 957mph/Mach 1.45

Max altitude: 71,900ft



US Air Force pilot, Captain Charles E Yeager, broke the speed of sound on the October 14, 1947, in this very aircraft. Attaining a speed of 700 miles per hour or Mach 1.06, the plane, nicknamed Glamorous Glennis after the pilot's wife, entered the record books. The X-1 wasn't launched in the orthodox way and was instead propelled via air-launch from the bomb bay of a Boeing B-29. The record attempt wasn't the last of the X-1's record breakers, though. On March 26, 1948, it reached the highest velocity and altitude of a

manned airplane up to that time. A single engine, single seat aircraft, 'Glennis', broke all idea of a sound barrier using a liquid fuelled 6,000-pound thrust rocket engine. The aircraft was one of a kind, shaped like a .50-caliber bullet—a round that was stable in supersonic flight when fired from a gun. The design was so good that the X-1 programme helped provide the inspiration for the space programme that would begin in subsequent decades. One of the most important aircraft of all time, the Bell X-1 ushered in a new era; the supersonic age.



HOW IT WORKS

ICONIC AIRCRAFT

12 most iconic aircraft

Supermarine Spitfire

The heroic British fighter of World War II that took the fight in the skies back to the German Luftwaffe



One of the most enduring images of the Second World War, the Spitfire is credited with saving the British Isles from the threat of German invasion. Fast, maneuverable and with an iconic engine sound, the Spitfire combined well with the Hawker Hurricane against the threat of the Messerschmitts. The Battle of Britain wasn't the Spitfire's only major contribution. It served the Allies with distinction over the course of the war, becoming the most widely produced British fighter of the war. It was constantly upgraded to battle the best the Luftwaffe had to offer and

fought in every theatre of the war. D-Day and the invasion of Sicily wouldn't have happened if it wasn't for the excellent air support the Spitfires provided. A Seafire version was created specifically for use in the Royal Navy on aircraft carriers and they became invaluable in the battle in the Pacific against Japan. Quintessentially British, the Spitfire was sold to various air forces around the world after the war but remains an icon of plucky British resistance in the summer of 1940. It is estimated that over 20,000 Spitfires were made and around 50 are still flying today as its legendary status lives on.

The statistics...



Supermarine Spitfire

Launch date: 1936

Length: 29.11ft

Weight: 4,976lb

Wingspan: 36.10ft

Max speed: 362mph

Max altitude: 35,00ft

Years in service: 19

"The Spitfire remains an icon of plucky British resistance in the summer of 1940"

High flyer

As well as being a more than capable fighter, the Spitfire's high service ceiling allowed it to be an effective reconnaissance aircraft, gathering valuable enemy information.

Strategy

Boasting superior maneuverability, Spitfires would take down the more nimble German fighters while the Hurricanes went for the Luftwaffe bombers.

Bullet proof

Many Spitfires had their fuel tanks lined with linatex rubber to prevent leaks and fire when they were struck by bullets.



DID YOU KNOW? The first aircraft to make a solo transatlantic flight, the St Louis stayed in the air for 33.5 hours!

Spirit of St Louis

With a prize of \$25,000, US pilot Charles Lindbergh jumped at the chance to pilot the famous monoplane

The statistics...



Spirit of St Louis

Launch date: 1927

Length: 27.7ft

Weight: 5,135lb

Wingspan: 46ft

Max speed: 120mph

Fuel space

The extra fuel tanks required for the transatlantic journey were so big that the aircraft's capacity was cut from five persons down to one!



Flight preparation

To be able to make the daring trip, the aircraft's wingspan was lengthened and a larger fuselage was constructed to accompany the increased fuel tank.

Power

The plane was powered by a 223-horsepower Wright Whirlwind air-cooled J-5C engine, which allowed it to make it all the way from New York to Paris.



After the Wright Brothers and their contemporaries had made flight achievable, aviators competed to take aviation to an even higher level. Charles A. Lindbergh was one of these men and in May 1927 competed for \$25,000 to be the first to cross the Atlantic non-stop. French hotel owner Raymond Orteig had a great passion for flying and offered

the best pilots in the world the cash prize. Lindbergh and the Spirit of St Louis were the ideal team to undertake the task. The plane had been specifically constructed for the mission and in test flights it managed to break the transcontinental record by flying from San Diego to New York in 21 hours and 40 minutes. Any item that wasn't needed was removed so Lindbergh

was forced to fly with no radio, parachute or navigation lights! The historic journey was made between May 20-21 and the Spirit of St Louis was in such good shape, it was constantly flown around the Americas for years by Lindbergh to increase interest in aeronautics. The plane is now at the Smithsonian National Air and Space Museum in Washington, D.C., forever an icon.



Military



54

22 F-35 and future fighters
Meet the next-generation of stealth fighters offering all-round air supremacy

28 Aerobatic displays
The amazing tech behind the stunning aerial displays of the Red Arrows and Blue Angels

36 100 years of fighter planes
From World War I to modern day, inside the most iconic military aircraft

44 Supermarine Spitfire
What made the Spitfire such a spectacular aircraft in the Second World War?

46 Lancaster bomber
Undertaking some of the

most dangerous missions of WWII

48 Sea Harrier
Dominating the subsonic jet fighter field, the Harrier changed fighter dynamics

50 Sea Vixen
Next-generation firepower in an all-weather jet fighter

52 Westland Lynx
Can any other vehicle beat the Westland Lynx's records?

54 Strategic bombers
Take a look at the dedicated bombing aircraft of war

58 Attack helicopters
Explore the world's deadliest military gunships

48





58



46



22



HOW IT
WORKS

MILITARY AIRCRAFT

Next-gen stealth fighters



F-35 AND THE FUTURE FIGHTERS

Legacy aircraft worldwide are being blown out of the skies by a formation of revolutionary multi-role fighter jets, offering all-round air supremacy and a lethal barrage of explosive new technology

5 TOP FACTS

F-35 Lightning II

Birth

1 The F-35 was born out of the joint strike fighter (JSF) programme, which was initiated to create an aircraft that would replace the F-16, A-10, F/A-18 and AV-8B tactical fighter jets.

X-35

2 The prototype F-35 was the Lockheed Martin X-35, which narrowly beat a rival design from Boeing (X-32), despite both aircraft exceeding or meeting the JSF requirements.

DoD

3 Interestingly, the F-35 designation of the Lightning II is out of sequence with standard DoD numbering. It was supposed to be named the F-24 instead.

Alliance

4 There are eight global partners in the F-35's development along with the USA: the UK, Italy, the Netherlands, Australia, Canada, Denmark, Norway and Turkey.

LiftSystem

5 The STOVL variant of the F-35 Lightning II uses the Rolls-Royce LiftSystem, an innovative propulsion system that allows for the main engine exhaust to be redirected for vertical lift.

DID YOU KNOW? Total development costs of the F-35 Lightning II are estimated to have run to \$40 billion

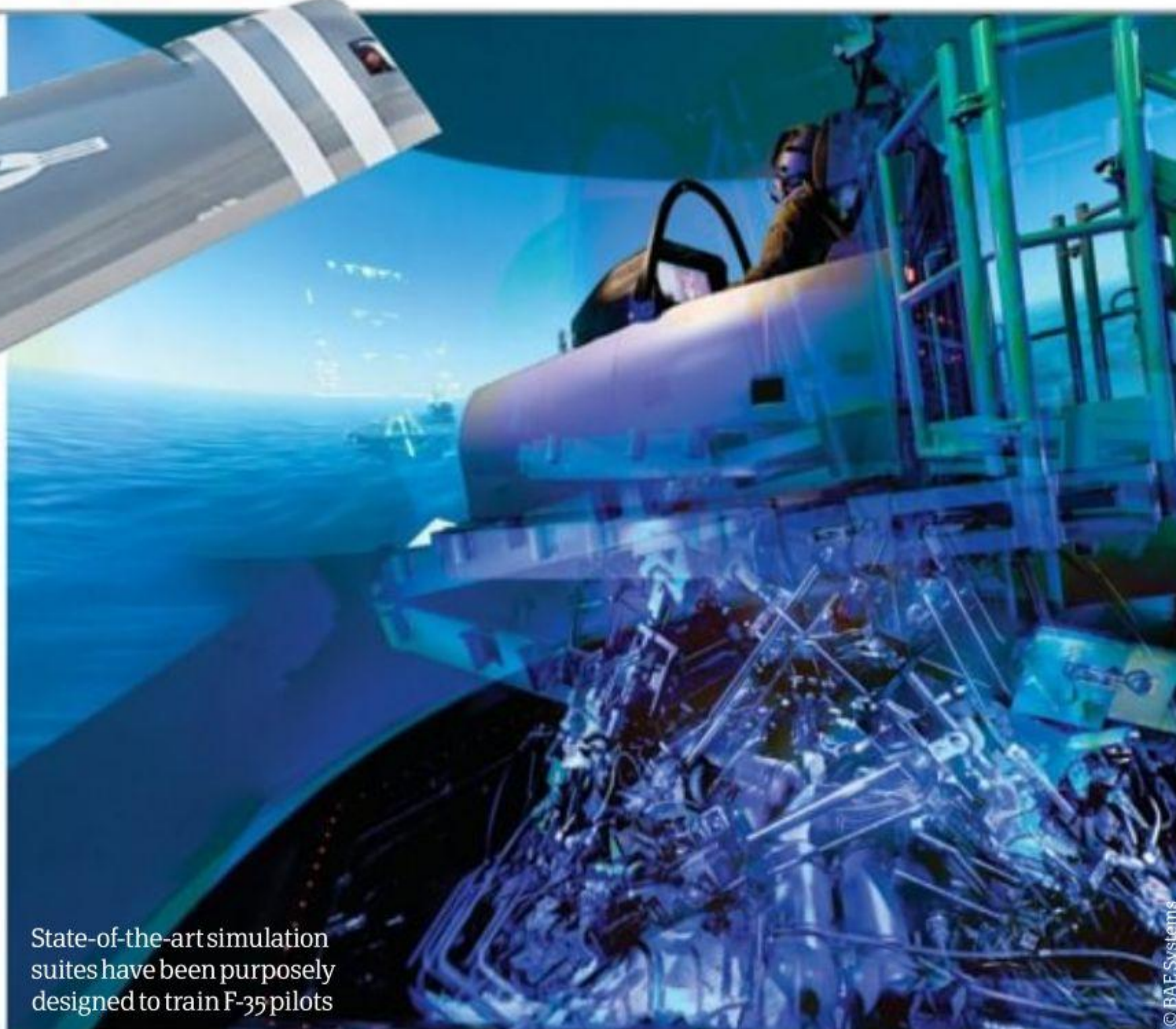

State-of-the-art simulation suites have been purposely designed to train F-35 pilots

F-35 Lightning II

Put simply, the most versatile, deadly and technologically advanced fighter jet in the world



The latest and greatest 'black project' from Lockheed Martin's Skunk Works—technically referred to as the Advanced Development Programs (ADP) unit, a classified division of the company unrestrained by bureaucracy—the F-35 Lightning II is the most advanced fighter jet on Earth. It's the first and only stealthed, supersonic, multi-role fighter.

Born out of a demand to dominate the fluid 21st-century battlefield, replacing a plethora of legacy aircraft such as the F-16 and A-10 Thunderbolt II, the F-35 is rewriting the rulebook on aircraft design, capable of performing almost any possible role imaginable today—be that strike, support or reconnaissance—with greater efficiency than any other aircraft made to date. The cost of this performance? \$139 million per plane.

So what does all that cash actually buy you? To start, the most powerful powerplant ever fitted to a fighter aircraft. The F-35, across all its three variants—read: F-35A, F-35B and F-35C, differentiated largely by takeoff mechanism—is fitted with a Pratt & Whitney F135 afterburning turbofan jet engine, which delivers a mighty 43,000 pounds of thrust and grants a sound-shattering top speed of over 1,200 miles per hour; that's over Mach 1.6 or, to put it another way, infinitely faster than your granny's Mini Metro!

The cash, which is being dropped in large quantities by the States, as well as eight other global partners including the United Kingdom—which is set to deploy the aircraft on its new Queen Elizabeth-class aircraft carriers—also purchases the

operator one of the most advanced aircraft structures in existence. Each F-35 utilizes structural nanocomposites, such as carbon nanotube-reinforced epoxy and bismaleimide (BMI), to produce a framework unrivalled in lightness and strength, as well as heavily integrating epoxy glass resin to maximize aerodynamics. In terms of skin and coatings, each F-35 aircraft sports a radar cross-section the size of a golf ball thanks to the implementation of fibre-mat over the fuselage.

The cockpit is also state of the art, delivering a full-panel-width, panoramic glass cockpit display as well as a host of bleeding-edge avionics and sensors such as the Northrop Grumman AN/APG-81 AESA radar and electro-optical targeting system (EOTS). Further, much of the cockpit has been optimized for speech-recognition interaction, allowing the pilot to control many parts of the jet by voice alone.

The rate of climb of the F-35 is 45,000ft per minute



"Each F-35 utilizes structural nanocomposites, such as carbon nanotube-reinforced epoxy and bismaleimide"

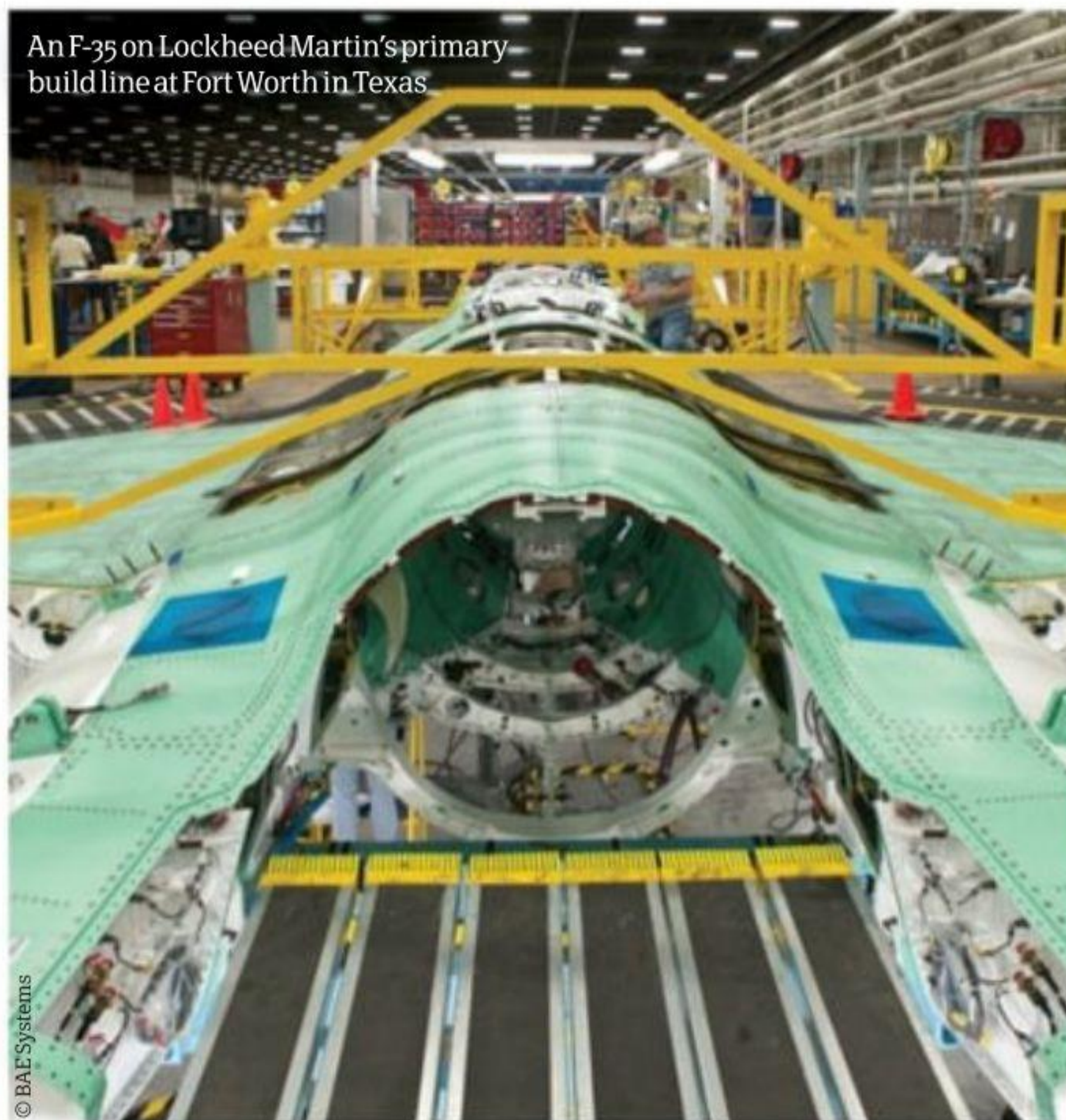

An F-35 on Lockheed Martin's primary build line at Fort Worth in Texas

Of course, the main attraction of the Lightning II is its diverse armaments—the equipment that transforms it from technical marvel into a master of destruction. You want air-to-air prowess? You've got it, with the F-35 capable of launching AIM-120 AMRAAMs, AIM-9X Sidewinders, IRIS-Ts and the futuristic beyond-visual-range MBDA Meteor. For maximum air-to-ground penetration, take your pick from AGM-154 JSOWs, SOM Cruise Missiles and Brimstone anti-tank warheads. Even if you want to engage marine-based targets the F-35 delivers the goods, capable of launching the new anti-ship Joint Strike Missile (JSM). Throw in a raft of other munitions, including the Mark 80 series of free-fall bombs, an Mk.20 Rockeye II cluster bomb, the Paveway series of laser-guided bombs and even, in DEFCON 1 situations, the B-61 nuclear bomb and you have one extremely versatile, powerful and deadly feat of aviation.





HOW IT WORKS

MILITARY AIRCRAFT

Next-gen stealth fighters



LiftSystem

Made by tech-masters Rolls-Royce, the F-35's LiftSystem is an innovative propulsion system that allows for the main engine exhaust to be redirected for direct vertical lift. Perfect for carrier deployment.

Anatomy of the F-35 Lightning II

How It Works breaks down this awesome piece of military engineering to see what makes it so advanced

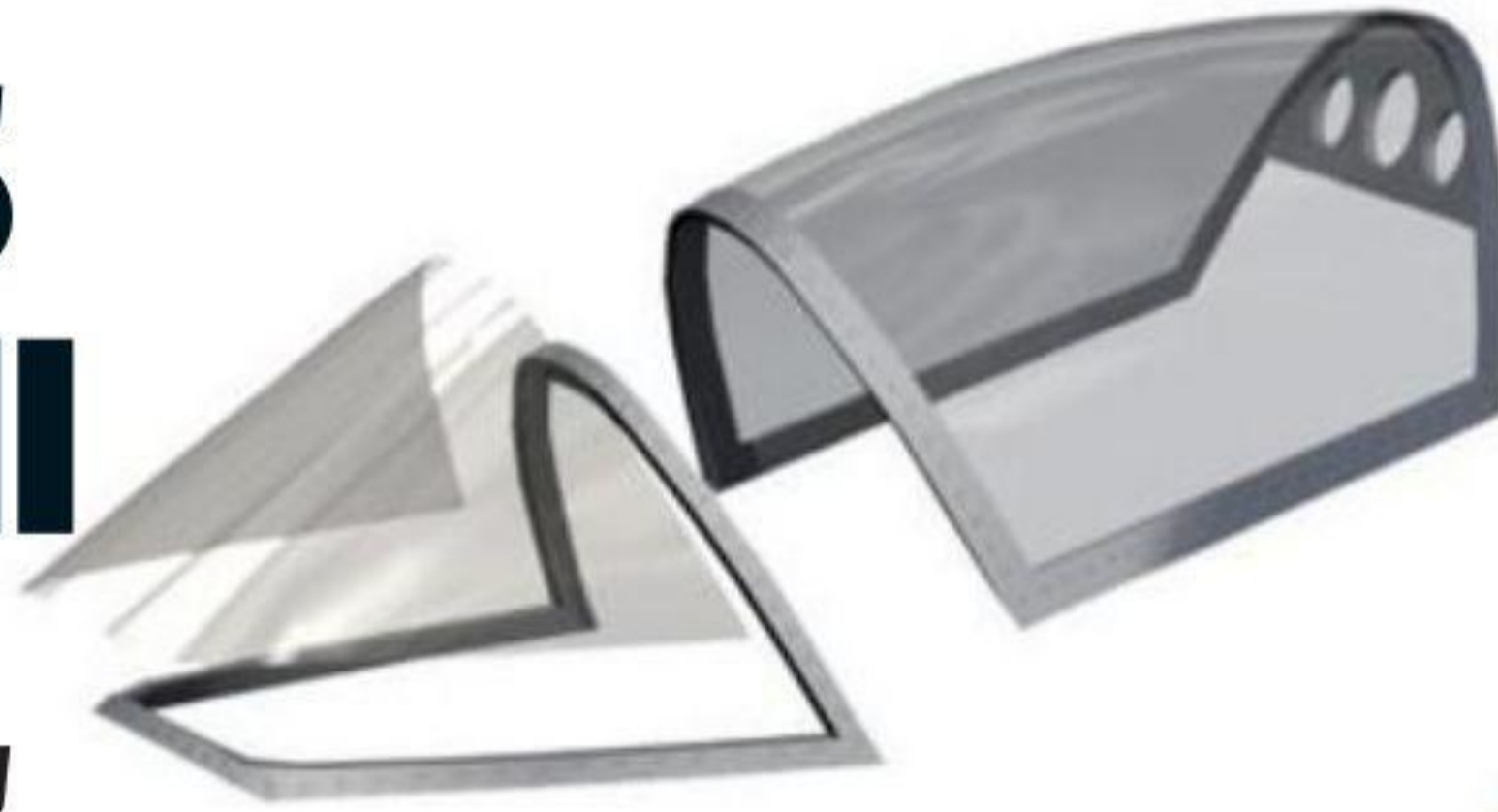

Cockpit

A panoramic glass cockpit display (PCD) is standard on the F-35, allowing unparalleled visibility. Speech-recognition systems also offer audio control of parts of the pilot interface.



© BAE Systems

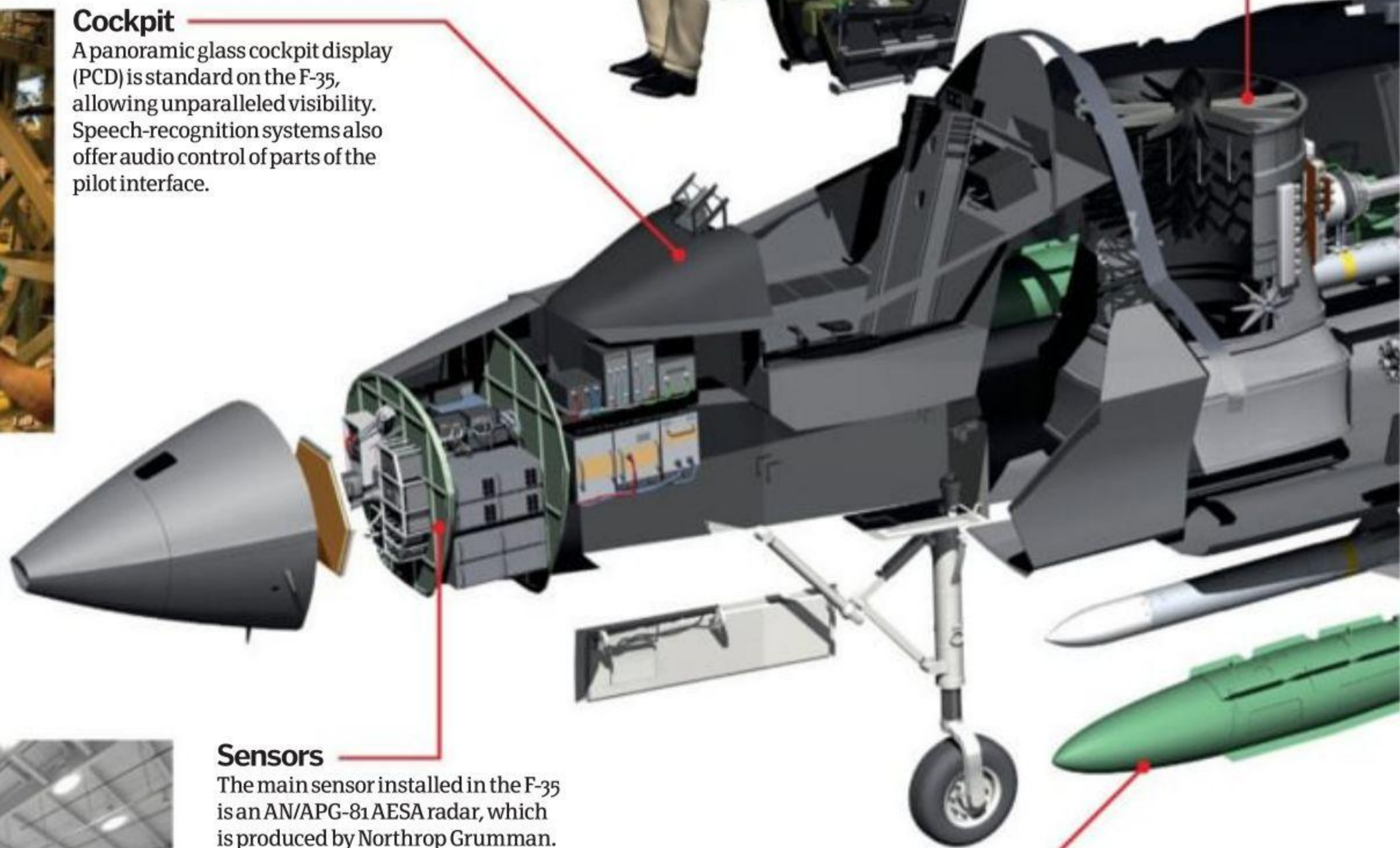

Sensors

The main sensor installed in the F-35 is an AN/APG-81 AESA radar, which is produced by Northrop Grumman. This main radar is augmented with an electro-optical targeting system (EOTS) mounted under the nose.



© BAE Systems

Armament

Asides from a stock GAU-22/A quad-barrelled cannon, the F-35 can carry a wide variety of bombs and missiles, ranging from AIM-9X Sidewinders, through AGM-128s and on to JDAM-guided bombs.

History of multi-role fighter jets

The F-35 is the culmination of more than 30 years of development into producing a single, king-of-all-trades fighter plane

1979 Panavia Tornado

The first multi-role fighter to be produced, the Panavia Tornado—across its three variants (each providing differing abilities)—offered its owner the best of striker, bomber, interceptor and reconnaissance aircraft.



1983 McDonnell Douglas F/A-18 Hornet

Maybe the most recognisable multi-role fighter until the F-22, the Hornet was an all-weather, carrier-capable fighter specializing in short/medium-range bombing ops.



1988 JAS-39 Gripen

Another early delta-wing, multi-role fighter, the Gripen was designed to be incredibly lightweight for a fighter and sported impressive air-to-ground bombing capabilities. It has recently been upgraded for continued use.



DID YOU KNOW? The F-35 has the capability to carry and launch a B-61 nuclear bomb

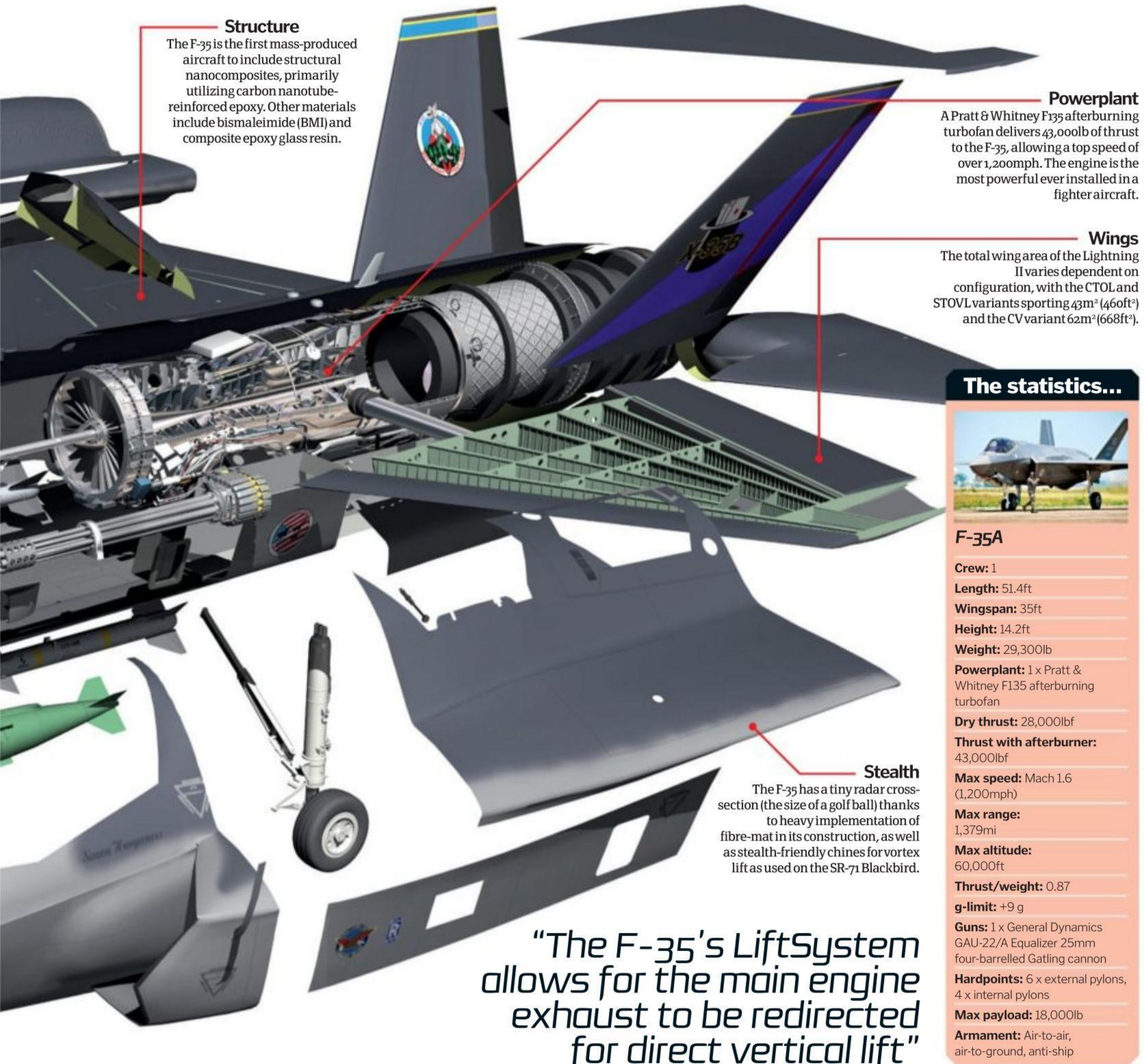

Structure

The F-35 is the first mass-produced aircraft to include structural nanocomposites, primarily utilizing carbon nanotube-reinforced epoxy. Other materials include bismaleimide (BMI) and composite epoxy glass resin.

Powerplant

A Pratt & Whitney F135 afterburning turbofan delivers 43,000lb of thrust to the F-35, allowing a top speed of over 1,200mph. The engine is the most powerful ever installed in a fighter aircraft.

Wings

The total wing area of the Lightning II varies dependent on configuration, with the CTOL and STOVL variants sporting 43m² (460ft²) and the CV variant 62m² (668ft²).

The statistics...



F-35A

- Crew:** 1
- Length:** 51.4ft
- Wingspan:** 35ft
- Height:** 14.2ft
- Weight:** 29,300lb
- Powerplant:** 1 x Pratt & Whitney F135 afterburning turbofan
- Dry thrust:** 28,000lbf
- Thrust with afterburner:** 43,000lbf
- Max speed:** Mach 1.6 (1,200mph)
- Max range:** 1,379mi
- Max altitude:** 60,000ft
- Thrust/weight:** 0.87
- g-limit:** +9 g
- Guns:** 1 x General Dynamics GAU-22/A Equalizer 25mm four-barrelled Gatling cannon
- Hardpoints:** 6 x external pylons, 4 x internal pylons
- Max payload:** 18,000lb
- Armament:** Air-to-air, air-to-ground, anti-ship

Stealth

The F-35 has a tiny radar cross-section (the size of a golf ball) thanks to heavy implementation of fibre-mat in its construction, as well as stealth-friendly chines for vortex lift as used on the SR-71 Blackbird.

"The F-35's LiftSystem allows for the main engine exhaust to be redirected for direct vertical lift"



1996 Sukhoi Su-30

Envisioned as a fighter jet with excellent air-to-surface deep interdiction prowess (the ability to strike hostile targets at extreme range from friendly forces), the Russian Su-30 typifies multi-role designs from the mid-1990s.



© Sergey Krivchikov

2000 Dassault Rafale

Marketed by Dassault as an 'omnirole' jet, the Rafale was an agile delta-wing fighter, specializing in air supremacy. A collapse in a multi-nation agreement, however, led it to be used for other roles by France and India.



2005 Lockheed Martin

F-22 Raptor
Originally conceived as an air superiority fighter, the F-22 evolved over time into a multi-role jet, capable of ground attack and electronic warfare roles thanks to its extremely low radar cross-section.



© Rob Shenik

© Alex Pang



“Typhoon pilots are now linked to their aircraft by ‘electronic umbilical cords’”

According to government officials, the T-50 will have a low radar cross-section and have the ability to supercruise (perform sustained supersonic flight)



© Maxim Maklakov

Sukhoi T-50

Russia’s hottest jet project currently in development, the highly classified Sukhoi T-50 is a fifth-generation multi-role fighter designed to deliver awesome long-range strike capabilities

Arguably the main competitor to the F-35 Lightning II, the Russian-made Sukhoi T-50 is an extremely advanced, twin-engine, multi-role jet fighter that, aside from being a top-level black project (in other words, highly hush-hush), promises to deliver an insane top speed, range and payload.

Power, which is titanic—267 kilonewtons (66,000 pounds of force) of thrust on afterburner—comes courtesy of two Saturn 117 turbofan jet engines. The thrust has been drastically increased since the previous AL-31 powerplant and this not only allows the T-50 to easily surpass Mach 2 (a top speed of 1,500 miles per hour) but also supercruise—continuously fly at supersonic speeds without engaging the afterburner.

The reason for the twin-engine setup, as well as the supersized fuel tanks, is to help fulfil the T-50’s design focus to specialize in long-range interdiction operations (striking at enemy targets that are located at a great range from allied forces). This is a core competency for modern Russian military bombing aircraft due to the size of the country and the great distances between stopover points.

Avionics are handled by an integrated radar complex, which includes three X-band active electronically scanned array (AESA) radars mounted to the front and sides of the aircraft, an infra-red search and track (IRST) system, as well as a pair of L-band radars on the wing leading edges, which are specially designed to detect very low observable (VLO) targets.

In terms of firepower, the production variant of the T-50 will boast up to two 30-millimetre cannons, as well as a mix of Izdeliye 810 extended-beyond-visual-range missiles, long-range missiles, K74 and K30 air-to-air short-range missiles and two air-to-ground missiles per weapons bay. Free-fall bombs can also be carried—with a limit of up to 3,300 pounds per bomb bay—as well as various anti-AWACS (airborne warning and control system) armaments, such as the RVV-BD variant of the Vypel R-37.

Since production began back in 2019, 21 T-50s have been built (including ten test aircraft). However, it is expected that more than 1,000 jets will be made, each unit costing between \$48-57 million.

The NIIP AESA radar is used on the production variant of the T-50

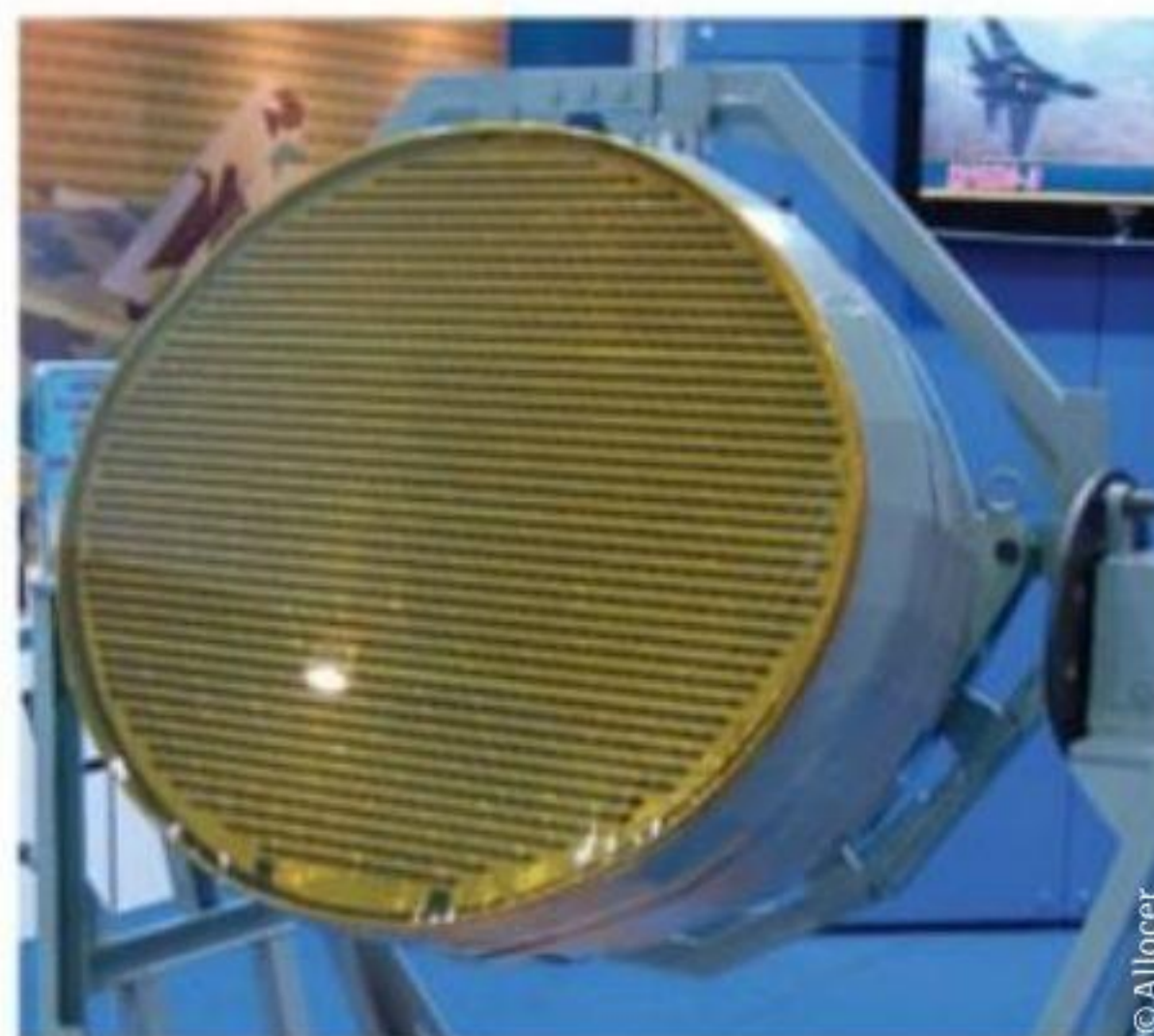

© Allocer

As well as air-to-air roles, the Typhoon can adapt to air-to-ground operations, delivering GBU-16 Paveway II bombs



The statistics...



© Dmitry Pichugin

Sukhoi T-50

- Crew:** 1
- Length:** 65.9ft
- Wingspan:** 46.6ft
- Height:** 19.8ft
- Weight:** 40,785lb
- Powerplant:** 2 x AL-41F1 afterburning turbofans
- Max speed:** Mach 2+ (1,560mph)
- Max range:** 3,417mi
- Max altitude:** 65,600ft
- Rate of climb:** Classified
- Thrust/weight:** 1.19
- g-limit:** Classified
- Guns:** 2 x 30mm cannons
- Hardpoints:** 6 x external pylons, 4 x internal pylons
- Armament:** Air-to-air, air-to-ground, anti-ship



ELECTRIC



Electronic warfare

Some jets use specialized equipment to control, disrupt or attack enemy targets with a host of cutting-edge electromagnetic weaponry.

CLOSE CALL



Close air support

Supporting ground troops with air action despite their close proximity. Achieved with fixed-wing or rotary aircraft.

LONG DISTANCE



Air interdiction

This role involves using aircraft to attack tactical ground targets that are not currently in close proximity to ground forces but located at a considerable range.

DID YOU KNOW? The Sukhoi T-50 is expected to be renamed to the Sukhoi PAK FA when it is officially launched in 2018



Eurofighter Typhoon

The Typhoon is one of the most adaptable multi-role fighters in operation today and has recently been upgraded to deliver enhanced air superiority and all-round lethality in its combat operations over the next decade

The Eurofighter Typhoon is currently one of the most agile aircraft in the world. It is so agile, in fact, that attempting to blow it out the skies is like trying to make a mile-long sniper shot in high wind. Why? It was built to be fundamentally aerodynamically unstable and, if it were not for its advanced fly-by-wire control system generating artificial stability, would be too much for even the most experienced pilot to handle. This instability, however, allows for pilots to perform some physics-bending maneuvers at just plain stupid speeds—read: upwards of Mach 2—delivering them a combative edge and helping to ensure total air supremacy.

Of course, agility alone can only take you so far—especially so when the hardware needs to fulfil almost every airborne military role imaginable. Good job then that the Typhoon can carry an abundance of weapons. You need to go toe-to-toe with enemy fighters in an air-to-air combat dogfight? No problem, take your pick from Sidewinder, ASRAAM and AMRAAM air-to-air missiles. Need to undertake a bombing run through hostile territory? Well, the Typhoon's 13 hardpoints allow for Maverick, HARM and Taurus munitions to be smartly delivered (via laser-guiding and GPS) with ice-cold efficiency. Need to disrupt a hostile target's comms network through a tactical electronic warfare strike... You get the point.

Supporting this awesome arsenal is an upgraded weapons system, which has been designed to unite the pilot and hardware like never before. Typhoon pilots are now linked to their aircraft by an 'electronic umbilical cord', which extends from a comms-optimized helmet directly into the jet's system. This not only allows images and videos of notable

contextual information to be directly fed to the helmet's visor for immediate consultation by the pilot, but also enables special nodules on the helmet to be tracked by fixed sensors in the aircraft's cockpit. As such, wherever the pilot's head moves, the airplane knows exactly where they are looking and can automatically prep weapon stores dependent on the perceived level of threat.

Any future fighter though also needs to be prepared to defend itself against a barrage of smart munitions, which again—thanks to the Typhoon's perpetual evolution—the hardware delivers in spades. The entire jet is protected by a high-integrated defensive aids sub-system (DASS), also nicknamed Praetorian. Praetorian consists of a wide array of sensors and electronic/mechanical systems—detection is handled by both a radar warning receiver and laser warning receiver—that automatically track and then respond to both air-to-air and surface-to-air threats. The plane can respond by releasing chaff (eg small bits of aluminium or metallized glass, etc), flares and electronic countermeasures (ECM), as well as by releasing a towed radar decoy (TRD).

As of May 2023, 589 Typhoons have been constructed, with 137 of them serving the British armed forces.

The statistics...



Eurofighter Typhoon

- Crew:** 1
- Length:** 52.4ft
- Wingspan:** 35.9ft
- Height:** 17.3ft
- Weight:** 24,600lb
- Powerplant:** 2 x Eurojet EJ200 afterburning turbofans
- Dry thrust:** 13,000lbf each
- Thrust with afterburner:** 20,000lbf each
- Fuel capacity:** 9,900lb internal
- Max speed:** Mach 2+ (1,550mph)
- Max range:** 2,350mi
- Max altitude:** 64,990ft
- Rate of climb:** 62,000ft/min
- Thrust/weight:** 1.15
- g-limit:** +9/-3 g
- Guns:** 1 x 27mm Mauser BK-27 revolver cannon
- Hardpoints:** 13 (8 x under-wing, 5 x under-fuselage)
- Max payload:** 16,500lb
- Armament:** Air-to-air, air-to-ground, anti-ship

A Typhoon undertakes a low pass at high speed



© BAE Systems

"The Typhoon's 13 hardpoints allow multiple munitions to be smartly delivered with ice-cold efficiency"

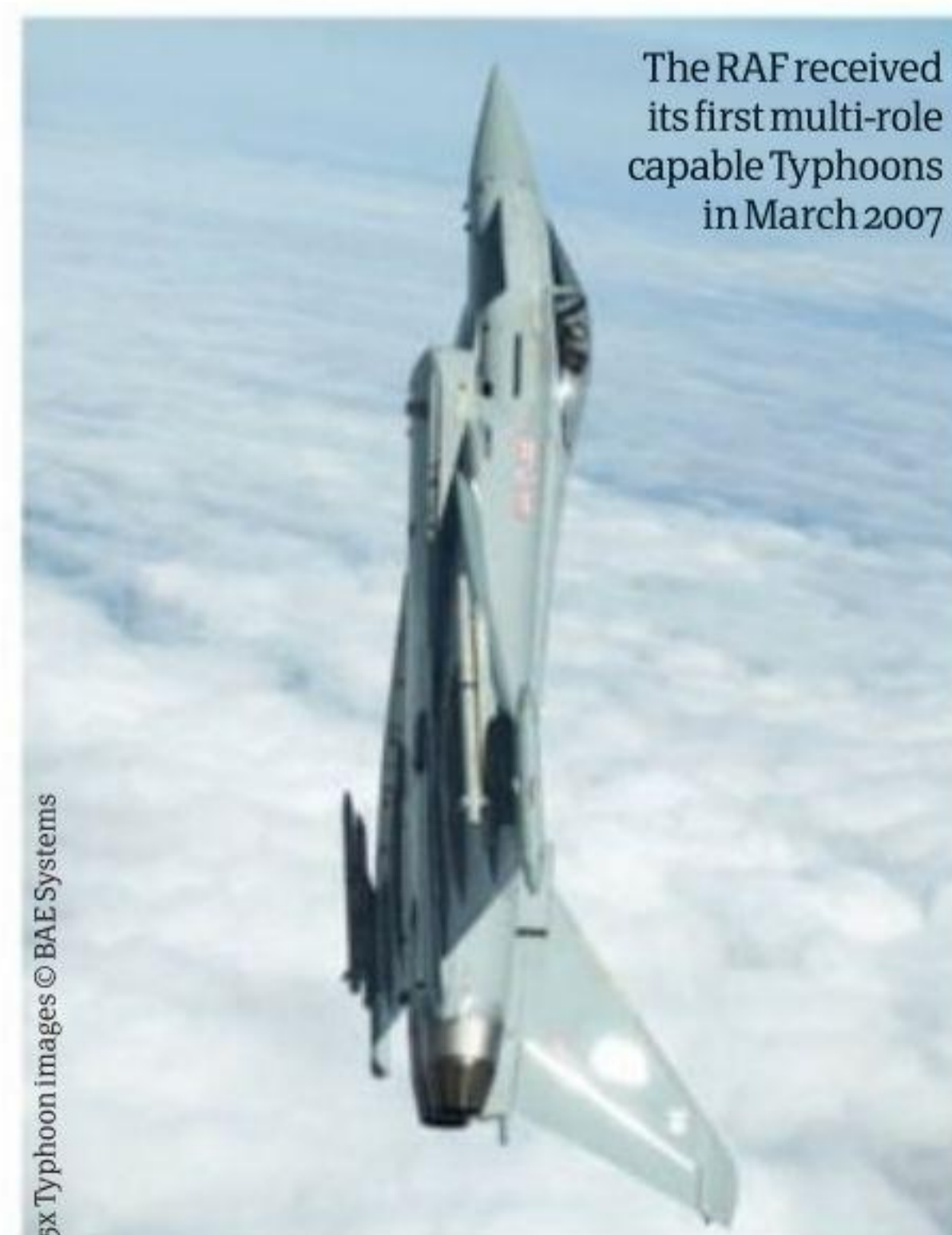

The RAF received its first multi-role capable Typhoons in March 2007

5x Typhoon images © BAE Systems



HOW IT
WORKS

MILITARY AIRCRAFT

Aerobatic displays

AEROBATIC DISPLAYS

THE AMAZING TECH BEHIND THE
DEATH-DEFYING DISPLAYS



DID YOU KNOW? The Red Arrows, whose motto is "Éclat", meaning brilliance, are based at RAF Scampton in Lincolnshire



Anyone who's seen the Red Arrows or the Blue Angels perform will know why many consider these pilots to be the world's best.

They execute death-defying stunts at breakneck speeds; flying low to the ground and experiencing g-forces that makes their heads feel like 44-pound balls. They manage not only to control their aircraft, but also to work perfectly in a team, pushing themselves and their aircraft to the limit.

The Blue Angels—the US Navy's flight demonstration squadron—and Red Arrows—the UK's Royal Air Force Aerobatic Team—have very interesting origins. After World War II ended, the US chief of naval operations, Admiral Chester Nimitz, was keen to maintain the high level of public interest in naval aviation. He feared that he would lose significant amounts of funding to other areas of the US Army; therefore, he devised a plan to create a flight exhibition team. Throughout the following decades, the Blue Angels flew a number of different planes, including the F6 Hellcat, the F-4 Phantom and the A-4 Skyhawk. They finally settled on the Boeing F/A-18 Hornet in 1986, the 40th anniversary of their conception, which they still use today. The Blue Angels now perform all over America, with air shows taking place between March and November.

The Red Arrows take their name from two aerobatic display teams that preceded them, the Red Pelicans and the Black Arrows. The first Red Arrow display team was formed in 1964 after concerns that aerobatic display pilots were neglecting their combat training, as they preferred to practice their stunts. The first official Red Arrows flew the Folland Gnat which had been used by the Yellowjacks in previous years. The original team flew with seven aircraft, until 1968 when they decided to adopt their now trademarked 'Diamond Nine' formation. In 1979, the BAE Systems Hawk—a modified version of the Royal Air Force's fast jet trainer—was chosen to replace the Gnat. The Red Arrows have now performed over 5,000 shows in 57 countries and celebrate their 60th season in 2024.

© Airfix; Alamy; US Navy



HOW IT
WORKS

MILITARY AIRCRAFT

Aerobatic displays

Death-defying displays

Find out how display pilots pull off their incredible maneuvers with precision and coordination

Both the Red Arrows and the Blue Angels update their show routine each year, which typically lasts between 20 and 30 minutes. They prepare three different displays and choose which one to perform by examining the weather conditions. A 'full' or 'high' show will be performed in clear weather, when the cloud base is over 4,500 feet high. This allows a full, looping display to be carried out and means that even at the top of each loop, the planes will remain visible.

If the cloud base is lower than this and conditions are overcast, a 'rolling' or 'low' display is performed. When the weather is particularly bad and the cloud base is below 2,500 feet, a 'flat' show is performed. This will include mainly flypasts and steep turns, as these are the only maneuvers that remain visible in such poor conditions.

The first five Red Arrow planes (Reds 1 to 5) are the front part of the overall formation, known as 'Enid'. The remaining three

planes, Reds 6 to 9, make up the rear section and are known as 'Gypo'. Reds 6 and 7 are the 'Synchro Pair' and will perform opposition maneuvers during the second half of the show. The Blue Angels also have a similar pair—the Blue 5 and 6.

Blue Angel 5 pilot Mark Tedrow explained the most challenging maneuver that he performs during shows.

"It's called the inverted tuck over roll, which is where I'm trying to hide my plane behind Blue 6, so the crowd only see one aircraft.

Last year we performed this upright, but this year we decided to make things harder and perform it inverted."

Being disciplined during a maneuver is vital for all display pilots. Hours of practice enable the Red Arrows to move nine aircraft as one. Red 2 pilot Mike Bowden, revealed how the Red Arrows achieve this visual feat.

"There's a perfect position to be in during all maneuvers and to achieve this we aim to triangulate a position on the Team Leader's aircraft. We use two reference points to put us in the right part of the sky, which helps us to ensure that we don't get too close. Six feet apart is close enough when you've got nine aircraft in one vicinity."

Dye in the sky

Both the Blue Angels and the Red Arrows use smoke as a visual aid for spectators, enabling them to follow a traceable path from each plane during the display. The Red Arrows are famous for their white, red and blue smoke (the colours of the Union Jack), while the Blue Angels stick to using just white smokes.

Adding small quantities of diesel into the jet exhaust pipe produces the vapor trails. As this diesel meets the high temperatures found in the exhaust it instantly vaporizes, creating a strong, visible, white smoke. The Red Arrow pilots change the smoke's colour by adding dye through switches on their control column.

Although they do add something extra to the display visually, these vapor trails have a more important function—they enable pilots to judge wind speed and direction and make it possible for the Team Leader and Synchro Leader to see each other even when they are separated by large distances. They are therefore essential to flight safety.



The Red Arrows can produce a vapor trail for seven minutes during a 30-minute display

DID YOU KNOW? The Blue Angels took their name from a New York nightclub that was called The Blue Angel

"The first five Red Arrows planes (Reds 1 to 5) are the front part of the overall formation, known as 'Enid'"



DISPLAY MANEUVERS

See the maneuvers that were performed to mark the 75th Anniversary of the Battle of Britain in 2015

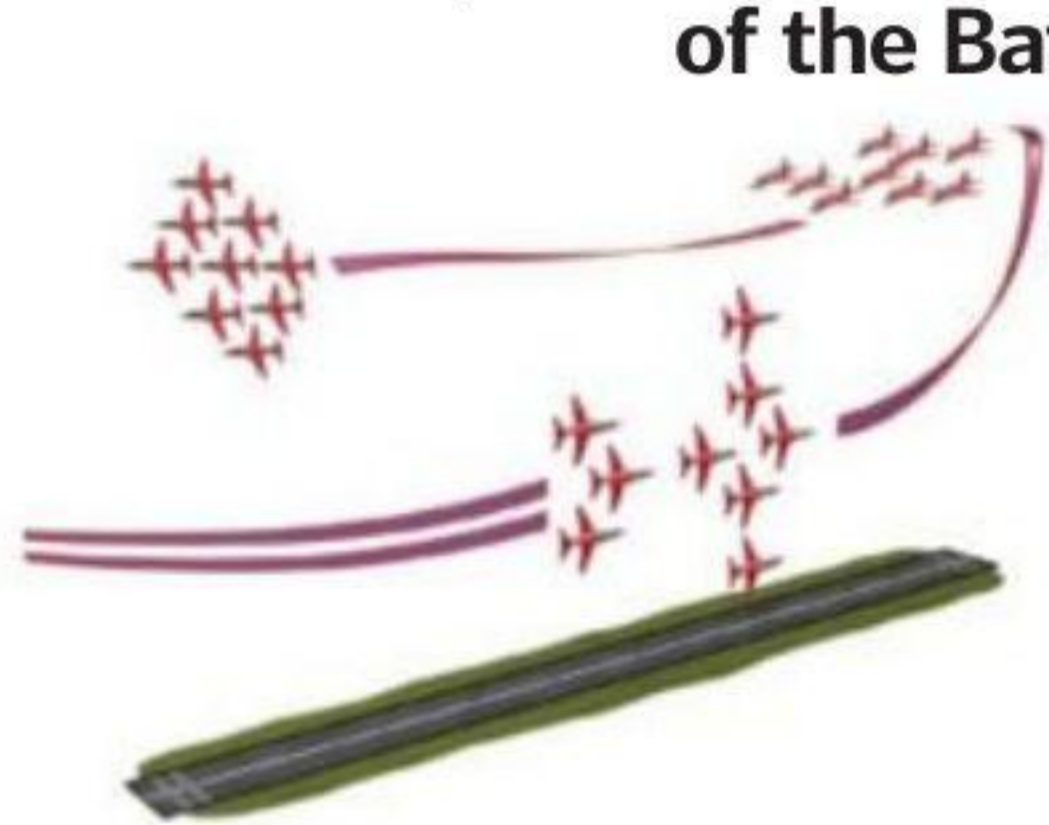

Spitfire Reversal

In recognition of the 75th anniversary of the Battle of Britain, the 2015 Red Arrows display featured them flying in the shape of a spitfire.

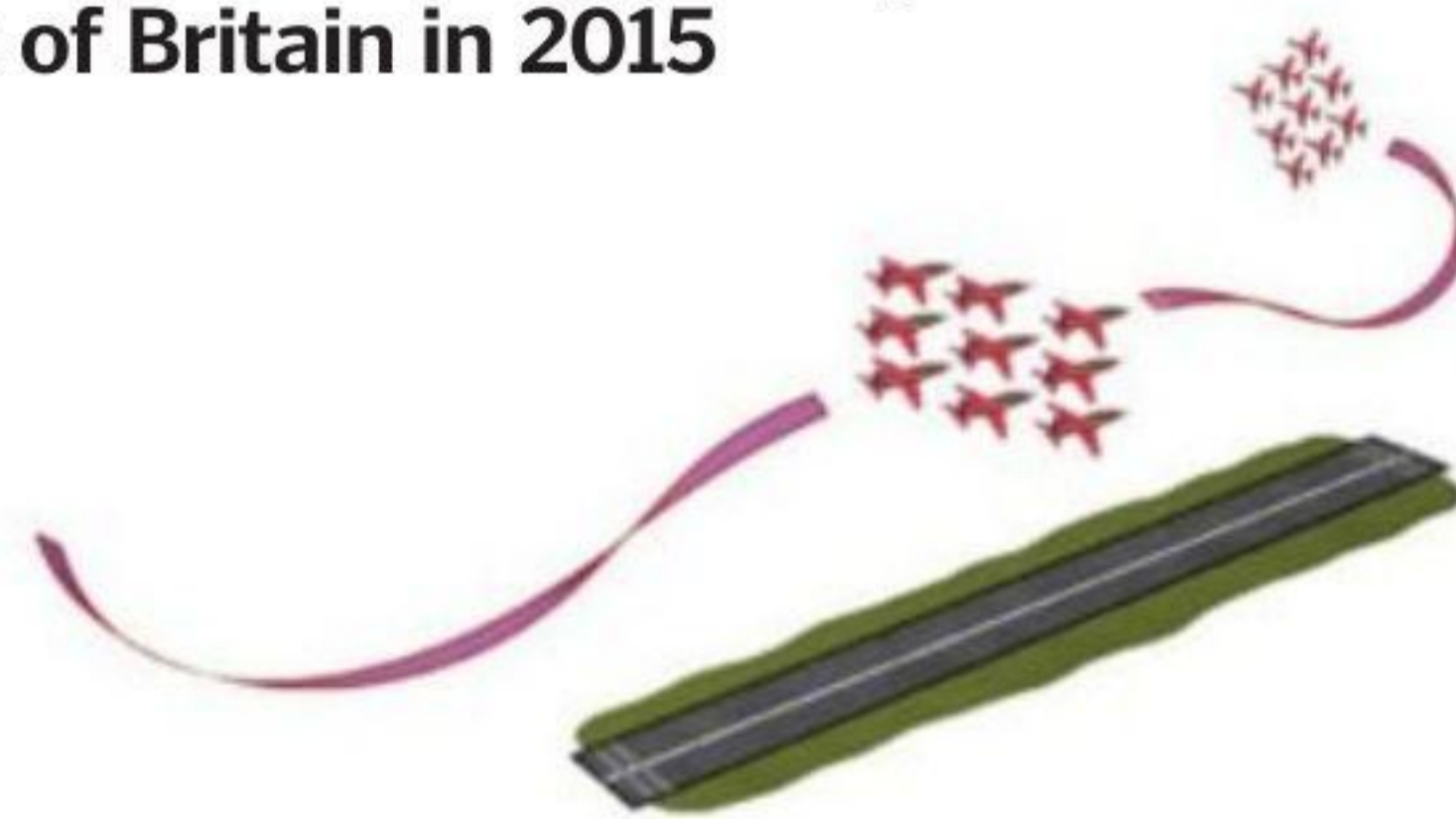

Whirlwind

The Whirlwind was introduced for the 2015 Red Arrow displays and features all nine jets performing a roll followed by a Blackbird loop.

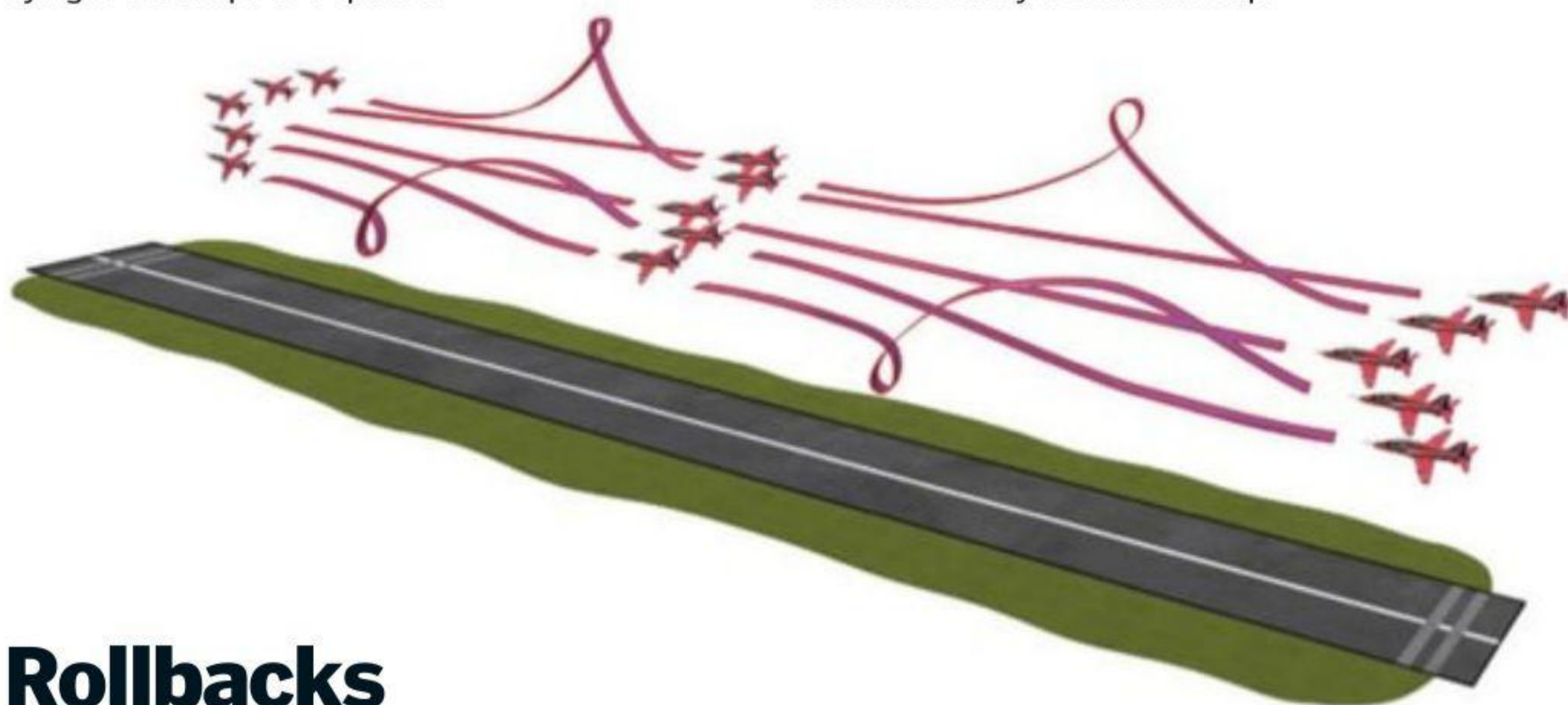

Rollbacks

Red 2 will pull out of the Diamond Nine formation and perform a full 360-degree roll around Red 4 and then himself outside of Red 4. At the same time, Red 3 will perform an identical maneuver around Red 5. The difficulty here is to keep the roll as tight as possible, and to time the rolls so that they are the same speed and look the same to the crowd.

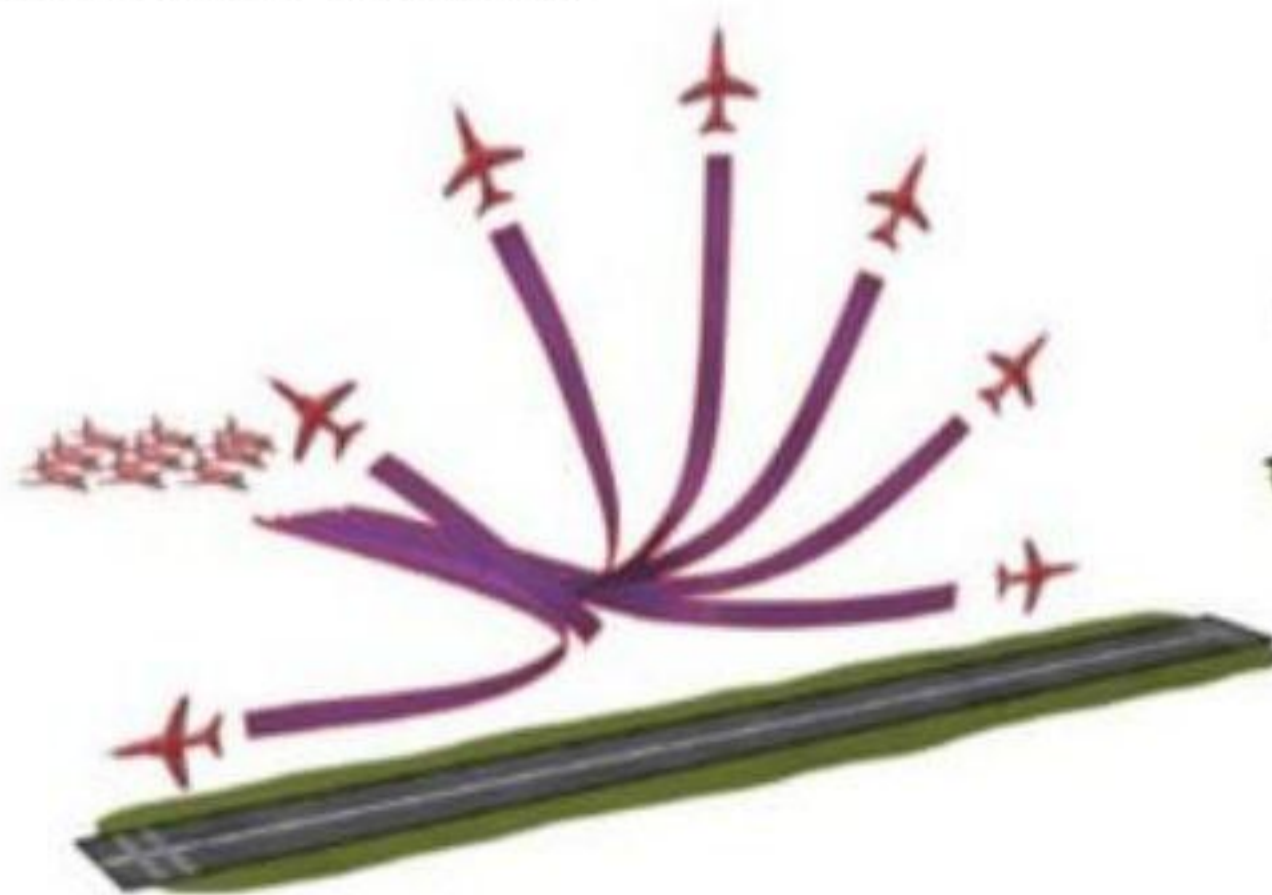

Vixen Break

All planes fly directly towards the crowd, before breaking in different directions up and away from the crowd, pulling up to 7g. This is often a crowd favourite, but is one of the simplest maneuvers to perform.

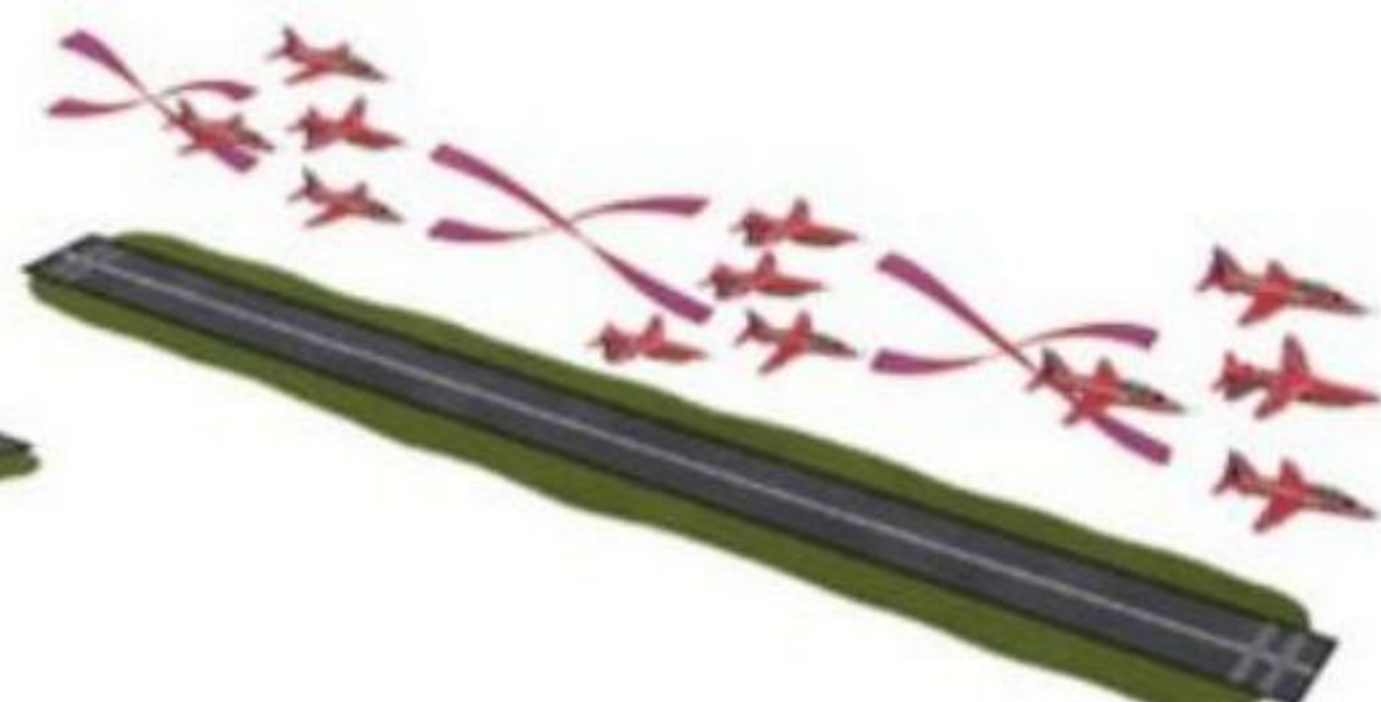

Mirror Roll

Throughout their 2015 displays, the Red Arrows revived the Mirror Roll, which involved Red 6 performing an inverted barrel roll at -2.5g, while Red 7, 8 and 9 remain in formation.



HOW IT WORKS

MILITARY AIRCRAFT

Aerobatic displays

"The high-speed crossing maneuver is much easier than rolling into formation"

Inside the moves

Explore what makes the awe-inspiring maneuvers work

All of the maneuvers performed by the Blue Angels are difficult in their own way, but some of the stunts that look the hardest are actually the easiest. An example of this is the high-

speed crossing maneuver, which is actually much easier to do than rolling into formation. This may look graceful, but it requires much more skill to perfect.

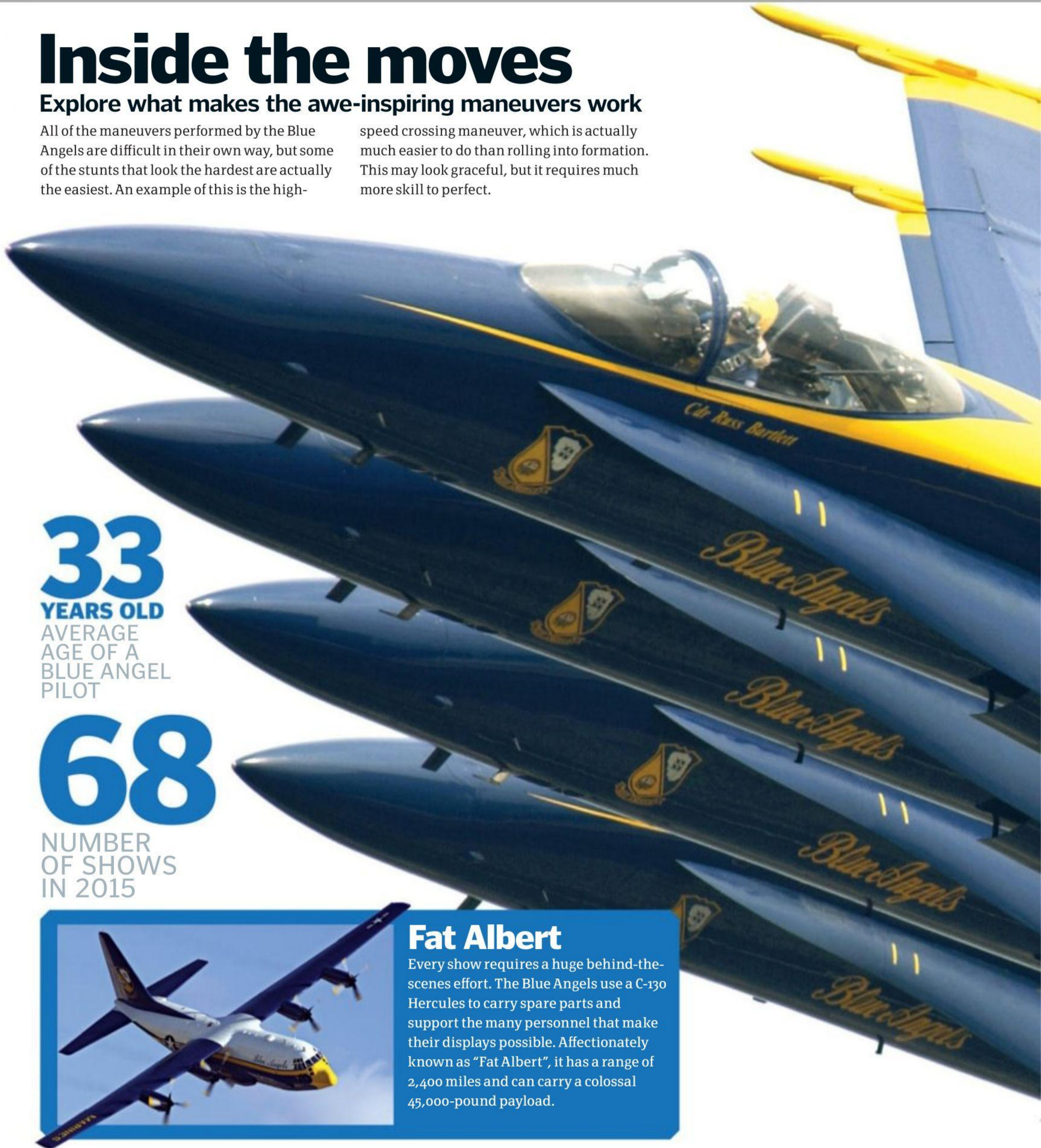

33
YEARS OLD
AVERAGE
AGE OF A
BLUE ANGEL
PILOT

68
NUMBER
OF SHOWS
IN 2015



Fat Albert

Every show requires a huge behind-the-scenes effort. The Blue Angels use a C-130 Hercules to carry spare parts and support the many personnel that make their displays possible. Affectionately known as "Fat Albert", it has a range of 2,400 miles and can carry a colossal 45,000-pound payload.

DID YOU KNOW? The Blue Angels perform an average of 70 shows a year in over 30 different locations



Double Farvel

This maneuver involves the first four Blue Angels. They perform a flypast in a very tight diamond formation while two of the planes, Blue Angels 1 and 4, are inverted.



Knife Edge Pass

To perform this maneuver, two planes fly towards the same point at high speed, before suddenly altering their position so they pass each other. This can be performed as low as 50 feet.



Section High Alpha Pass

This is the slowest maneuver the Blue Angels perform, and involves two of the jets slowing to 120mph as they pitch the noses of their planes up to an angle of 45 degrees.

1200 JET FUEL
GALLONS BURNT
PER
HOUR

11 MILLION

SPECTATORS PER
YEAR (ABOUT
THE SAME AS
THE POPULATION
OF GREECE)





HOW IT WORKS

MILITARY AIRCRAFT

Aerobatic displays

STAYING SAFE IN THE SKY

A number of steps are taken to keep aerobatic display pilots in one piece

The purpose of the Red Arrows and the Blue Angels is to thrill millions of spectators every year, but they never compromise on pilot safety. Due to the nature of their flying and the high number of shows they perform, accidents do happen, although they are less regular than they were when the aerobatic teams first performed. By studying both the pilots and the planes themselves, both teams are now aware of exactly how far man and machine can be pushed. Both the Blue Angel and the Red Arrow pilots wear specific safety equipment which enables them to perform their amazing displays with the minimum amount of danger.

Combating g-forces

We measure gravity in terms of how much acceleration a force applies to an object. During some of their daring maneuvers, aerobatic pilots will often be exposed to extreme gravitational forces. These forces direct their blood away from their brain and towards their feet, causing the heart to stop pumping sufficient blood back to the brain, which will eventually cause the pilot to totally blackout.

There are two ways that aerobatic pilots can counteract this problem. Red Arrow pilots wear a g-suit which employs a compressed air and bladder system. This compresses the legs and abdomen, reducing the likelihood of a blackout by reducing the amount of blood able to flow away from the brain.

Blue Angel pilots undergo specific training to enable them to fly without g-suits. This is because it is impossible to wear them when they fly, as they rest their forearms on their legs and use their knees as a fulcrum which the suits could interfere with if worn. Instead, they learn to tense their lower body muscles and exhale sharply (known as the 'hick' maneuver), that slows the rate at which the blood flows away from the brain. Blue Angel pilots are mandated to exercise at least six times a week, which keeps them fit and helps their bodies cope with g-force. On top of this, they train in a centrifuge each year which exposes them to extreme g-force and lets them practice dealing with its effects.

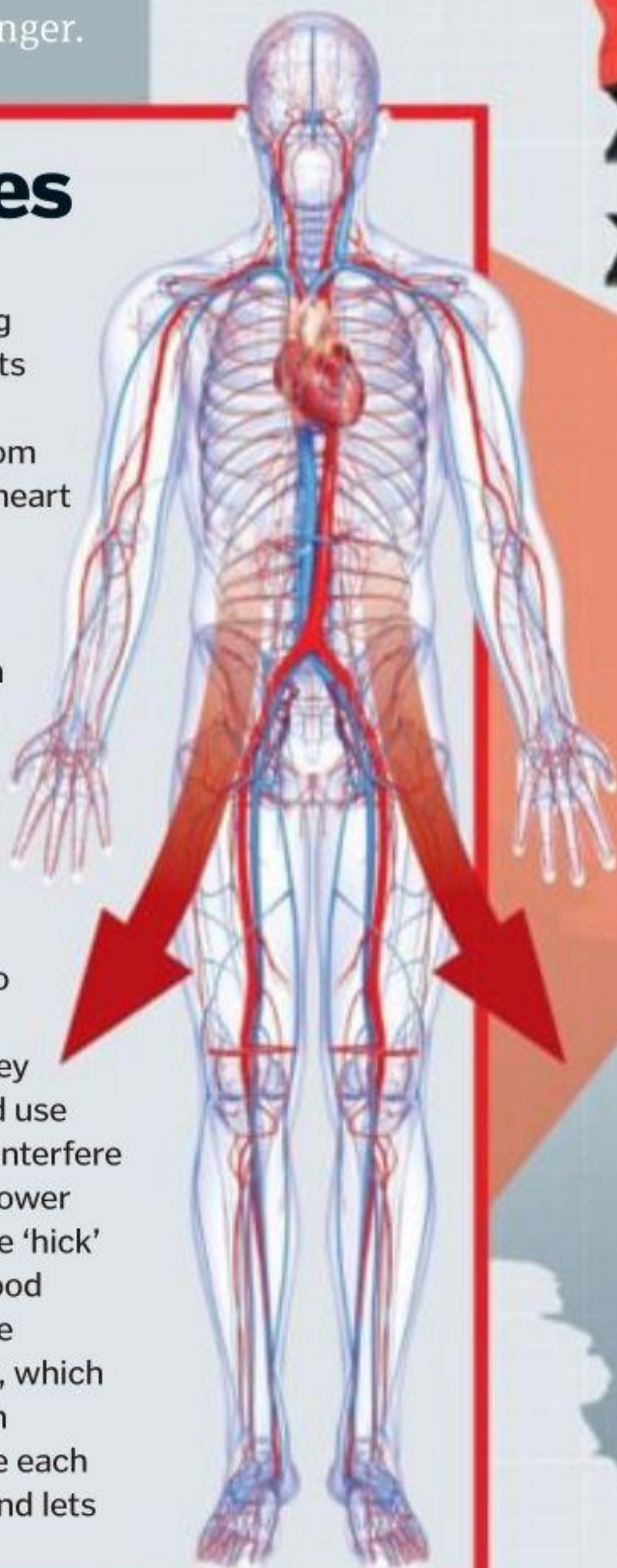

Flying helmet

Although it primarily functions to protect the pilot's head, the helmet houses the communications equipment as well.

Oxygen mask

The Red Arrow pilots all wear oxygen masks fitted with a microphone, but their Blue Angel counterparts do not, as they typically don't fly above 15,000ft.

Display flying suit

The Red Arrows and the Blue Angels have their own display suits accordingly coloured to suit their name. These are not worn during training.

Life preserver

The life preserver is equipped with vital survival aids, such as a locator beacon and mini flares.

Personal equipment connector

Red Arrow pilots use this to connect to their aircraft. It provides oxygen and also inflates their 'g' trousers.

Anti-g trousers

Unlike the Blue Angels, the Red Arrows wear anti-g trousers to prevent blood from rushing to their legs during maneuvers involving strong g-forces.



Above: The Blue Angels wear their iconic yellow helmet but do not wear an oxygen mask during performances



DID YOU KNOW? The Blue Angel jets can be made combat ready in less than 72 hours

What it takes to be a display pilot

Learn about the rigorous interview and training that future pilots have to face

The interview process for selecting a new member of a display team is incredibly thorough. In the case of the Blue Angels, there has to be a completely unanimous (16-0) vote in favour of a candidate in order for them to join.

The Red Arrows will shortlist nine potential pilots via a pre-selection board, who are then invited for the seven-day interview. During this time, the candidates will undertake a flying test, meet the current team, accompany a Red Arrow pilot during a display practice and be formally interviewed. Once this has been completed, the current team will meet to decide which applicants have been successful.

Flight lieutenant Mike Bowden, who pilots Red 2, explains how first-timers learn to fly in unison: "When you fly in formation on the front line, you wait for the aircraft around you to move and copy what they do," he says. "If we were to do this in the Red Arrows it would make the overall formation look very broken, which is why we learn to follow voice commands from the Team Leader). We aim to perfect formation flying before moving to complex maneuvers."

After meeting the initial criteria, Blue Angel applicants, or 'rushees' as they're fondly referred to, shadow the current pilots for numerous displays. They watch everything the existing team do, attend team briefs and go to social engagements. Candidates are then whittled down, with the remaining potential pilots put forward for a daunting one versus 16 interview, where all current Blue Angel pilots and officers ask the candidate a question.

After this, the current team sits down and decides which candidates will be joining the following year's team. We spoke to LCDR Mark Tedrow, the lead solo pilot for the Blue Angels, who revealed how they train: "The Blue Angels are so unique and the flying we do is very different to anything you do in the military—it really does feel like learning to fly all over again," he says. "Between the end of one season and the start of the next, we aim to accumulate 120 training flights. We are usually flying 15 times per week, which is a fairly gruelling schedule, but that means we can perform our maneuvers practically from muscle memory."



Blue Angels recruits have to complete a variety of survival challenges before earning their qualifications to fly with the team

The experience you'll need to qualify

With only three spots available each year, gaining a place in a display team needs a very specific set of skills

RED ARROWS

Education

Many pilots are educated to degree level, but this isn't a requirement.

Experience

- ✓ Completed a frontline tour of duty.
- ✓ Assessed as being above average in their flying role.
- ✓ An exceptional flying record that includes reports on operational flights.

Flying Hours

A MINIMUM OF

1,500

HOURS IS EXPECTED.

Becoming Team Leader

To apply to become Team Leader, or the 'Boss', a pilot must have completed a three-year tour with the Red Arrows earlier in their career, which makes the number of people that can apply for this role limited. The Royal Air Force personnel department will select the officer they believe is best suited to carry out the wide range of duties expected of a Team Leader.



BLUE ANGELS

Education

Many pilots are educated to degree level, but this isn't a requirement

Experience

- ✓ Experience in an F/A-18.
- ✓ Carrier-qualified, active-duty Navy or Marine Corps tactical jet pilot.
- ✓ Combat experience, usually in landing on and taking off from aircraft carriers.

Flying Hours

A MINIMUM OF

1,250

FLYING HOURS IS EXPECTED.

Becoming 'The Boss'

The Chief of Naval Air Training selects the 'Boss', the Blue Angels commanding officer. The Boss must have at least 3,000 tactical jet flight-hours and have also commanded a tactical jet squadron. The Commanding Officer flies the Number 1 jet and leads all of the formations.





HOW IT WORKS

MILITARY AIRCRAFT

100 years of fighter planes

1989 Harrier II

Introduced to active service in December 1989, the Harrier II is an example of a vertical and/or short-takeoff and landing (V/STOL) jet aircraft, perfect for use on aircraft carriers. It was frequently used in combat during missions in Kosovo, Iraq and Afghanistan.



1938 Supermarine Spitfire

The Supermarine Spitfire was used by the RAF and other Allied forces during WWII. It was designed as a short-range, high-performance interceptor aircraft, with a maximum speed of 370mph. Originally fitted with eight .303 Browning machine guns, it helped defend Britain's coastline during the Battle of Britain.



1983 F-117 Nighthawk

The F-117 Nighthawk was equipped with pioneering stealth technology and was designed to have a minimal radar cross-section, making it very hard to detect by traditional monostatic radars. During its 25 years of service, only one was ever lost in combat.



CELEBRATING

FIGHTEER

**FROM WWI
TO MODERN
DAY, INSIDE
THE MOST
ICONIC
MILITARY
AIRCRAFT**



From daring dogfights over World War I France, to the computer-powered prowess of the modern era's jet fighters, the history of aerial warfare is nearly as old as flight itself.

In 1915, Dutch engineer Anton Fokker devised an interrupter gear, a simple mechanism that allowed a fixed machine gun to fire through a plane's running propeller blades. The first plane to use this was the Fokker Eindecker, which was so effective it began what the British Royal Flying Corps referred to as the 'Fokker Scourge'. This sparked an

international race to create faster, more maneuverable and ever-more destructive aircraft.

By the end of the Great War, the tactical advantages of maintaining air superiority were well established and by 1939 and the dawn of the Second World War, another leap in aerial combat was already dominating the skies. Capable of hitting speeds of over 311 miles per hour, the Messerschmitt Bf 109 was over three times faster than the Eindecker. From its testing ground in the skies of the Spanish Civil War to the invasions of Poland and

DID YOU KNOW? Frenchman Adolphe Pégoud was named the first flying ace of WWI after shooting down five German aircraft



1916 Sopwith Pup

Equipped with a rotary engine and weighing only 787lb, it had a range of over 186mi. It was armed with only a single Vickers machine gun and has a fabric-covered, wooden framework. It was nicknamed the 'Pup' as it was smaller than the two-seat Sopwith 1.5 Strutter.

1949 F-86 Sabre

First used in 1949, the F-86 Sabre was used by more than 20 different nations prior to its eventual retirement in 1994. An example of a swept-wing, transonic jet fighter aircraft, it also featured a 'flying tail', which gave it superb maneuverability at altitude.



2005 Lockheed Martin F-22 Raptor

The F-22 Raptor is the leading stealth tactical fighter aircraft. Its F-119 engines are regarded as the most advanced ever produced. Pilots benefit from 360-degree awareness when flying. Their ability to super-cruise at Mach 1.5 without afterburners makes them particularly lethal.



100 YEARS OF PLANES

France in 1939 and 1940 respectively, this powerful, lightweight and well-armed fighter set a new precedent for fighter planes.

Aerial warfare was now recognized as the key to strategic success on the ground. Luckily, Allied machines, such as the Rolls Royce-powered Spitfire that was already in service at the outbreak of the war, were able to out-class their German rivals. In the final months of the war, however, the future of fighter aircraft had already taken to the skies. Though it came too late and in

too small a number to turn the tide of the war for Hitler and the doomed Third Reich, the Messerschmitt Me 262 was the first-ever jet fighter, capable of speeds of 541 miles per hour.

Some of the last propeller-powered combat was seen in the Korean War of 1950 to 1953, before the world fully entered into the jet age. The skies of the Cold War were tensely patrolled by Soviet MiG-15s, American F-15 fighters and some of the fastest planes ever engineered. Then specialist vertical takeoff and landing (VTOL) aircraft were

developed for deployments on aircraft carriers, while secret stealth and surveillance technology was covertly advanced to enable both sides to wage the war in the shadows.

In modern warfare the job of the fighter plane is still a crucial element. The new generation of computer-assisted jets are capable of more roles and simultaneous operations than ever before; reducing the risk to the pilot, increasing the threat to the enemy and ensuring complete dominance of the skies.



HOW IT WORKS

MILITARY AIRCRAFT

100 years of fighter planes

Modern-day tech

How the new generations of military tech changed the face of aerial warfare

Ever since the Messerschmitt Me 262, nicknamed the Swallow, first took flight in World War II, the jet age has seen fighter-plane technology soar. One key difference between the fighters of today and their ancestors is the need for flexibility. While warplanes were previously designed for specific tasks—such as fighter bombers, escort, or reconnaissance—today’s aircraft are expected to perform a range of roles, even simultaneously. For example, the Eurofighter Typhoon carries over a dozen brackets under its fuselage. This enables it to carry any combination of air-to-air or ground-attack armament, or extra fuel pods for prolonged sorties, fulfilling the potential for every combat role.

With machines becoming ever faster and weapons systems leaving little to no room for error, even the lightning reactions of the hardest flying maverick would struggle to last five minutes of air combat—that is, without the aid of computer technology. Though it goes without saying the role of a pilot still demands incredible levels of skill, endurance, multitasking and quick reactions under pressure, the onboard computer is now an essential component of any fighter plane.

The heads-up display (HUD), iconic from films such as *Top Gun*, was among the most important electronic upgrades to the cockpits of fighter jets. It relays target tracking, sensor, navigation and other data direct to the pilot. The HUD computer is connected to all the external and internal sensors of the aircraft, so it’s able to collate, prioritize and even give guidance based on this data. This has enabled pilots to quickly engage various threats, enact countermeasures and even land safely, all while keeping two eyes firmly focused on the danger zone.

Though within the last few decades fighter technology has leapt several generations, in step with the growing capabilities of computers, the principles of assisting pilot operation have remained the same. For example, the Human Machine Interface (HMI) and Flight Control System (FCS) of the Eurofighter accommodates voice input/output controls, Autopilot, Autothrottle and Flight Director Modes, all to assist handling. In addition, its latest generation of radar is able to identify and prioritize threats. With all this, it’s no wonder that fighter pilots still feel a special bond with these incredible machines.

Typhoon Tranche 3 Eurofighter

The technology inside Europe’s \$125-million fighter will take your breath away

Multifunction Information and Distribution System

The internal computer system incorporates all the autonomous sub-systems, such as targeting and monitoring, and presents them to the pilot through multiple cockpit and helmet displays.

Reinforced windows

The cockpit windows are made from super-resistant transparent acrylic called Röh 249, shaped to give the widest possible view for the pilot.

CAPTOR-E AESA Radar

Active Electronically Scanned Array radar is capable of tracking multiple air and surface targets simultaneously, providing 200-degree coverage and automatically locking on to potential targets.

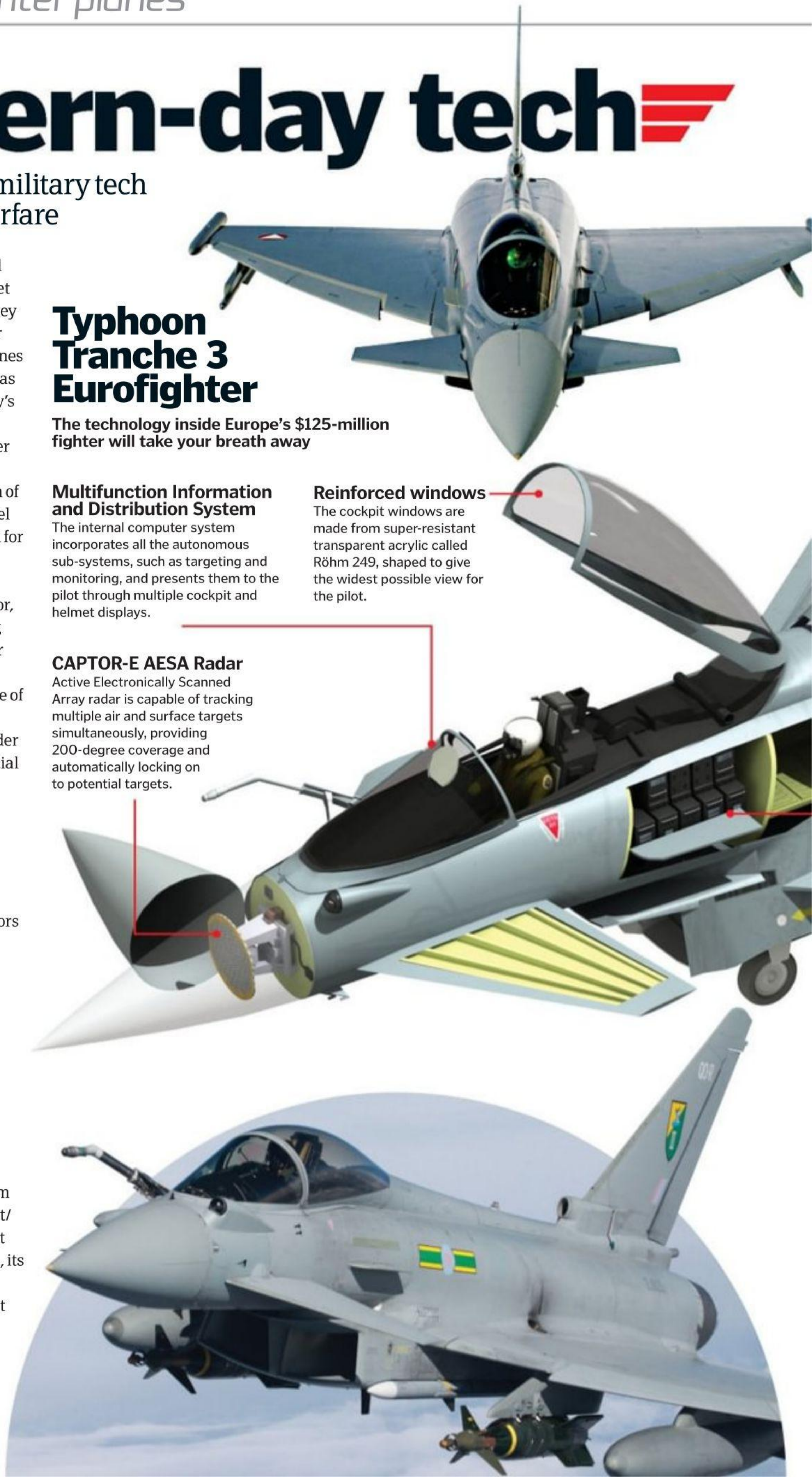

DID YOU KNOW? It is believed to cost around \$5,935 to keep a Typhoon flying for just one hour

Future-proof electronics

Fibre-optic data buses are built into the aircraft to ensure it will remain compatible with future generations of weapons systems.

Multi-role arsenal

With 13 sockets available, the weapons carriage can be equipped to suit any single or multiple roles. The latest Typhoon will be capable of carrying the Storm Shadow cruise missile.

Stealth material

Over 70 per cent of the Typhoon's airframe is made up of carbon-fibre composite material, making its surface deliberately unstable and less visible to radar.

Twin engines

Two EJ200 power plants combine to a total of 180kN (40,500lbf) of thrust, but are lightweight enough to ensure the aircraft can reach Mach 2.0.

DECMU

Each EJ200 is wired to a Digital Engine Control and Monitoring Unit (DECMU), which tell engineers the exact condition of the engine in order for them to extend its life span and apply enhancements.

Towed decoy

As a last resort, a decoy can be deployed by the plane's defense system as countermeasure to any hostile fire.

Defensive sensors

The Defensive Aids Sub-System (DASS) automatically monitors, prioritizes and responds to targets and threats from the outside world, both in the air and on the surface.

E-Scan radar

This watchful eye doesn't miss a thing

Wide view

The E-Scan is capable of monitoring multiple targets simultaneously, both ground and airborne, giving the pilot a 200-degree view of the battlefield.

Data link

As well as its primary radar functions, the E-Scan keeps pilots in contact with one another through Data Link capabilities.

Weapons integration

Fully connected to all the weapons systems, the radar can establish and lock on to targets without being prompted, leaving the pilot free to take instant action if required.

Air-to-ground ability

Some of the air-to-ground features include high-resolution maps, ground moving target identification and air-to-surface ranging.

High-res mapping

The E-Scan's increased range means pilots can conduct high-resolution synthetic-aperture radar (SAR) scans of the terrain below without coming into dangerous range with the enemy.



HOW IT
WORKS

MILITARY AIRCRAFT

100 years of fighter planes

AVIATION HISTORY

Discover how warplanes have developed through the ages

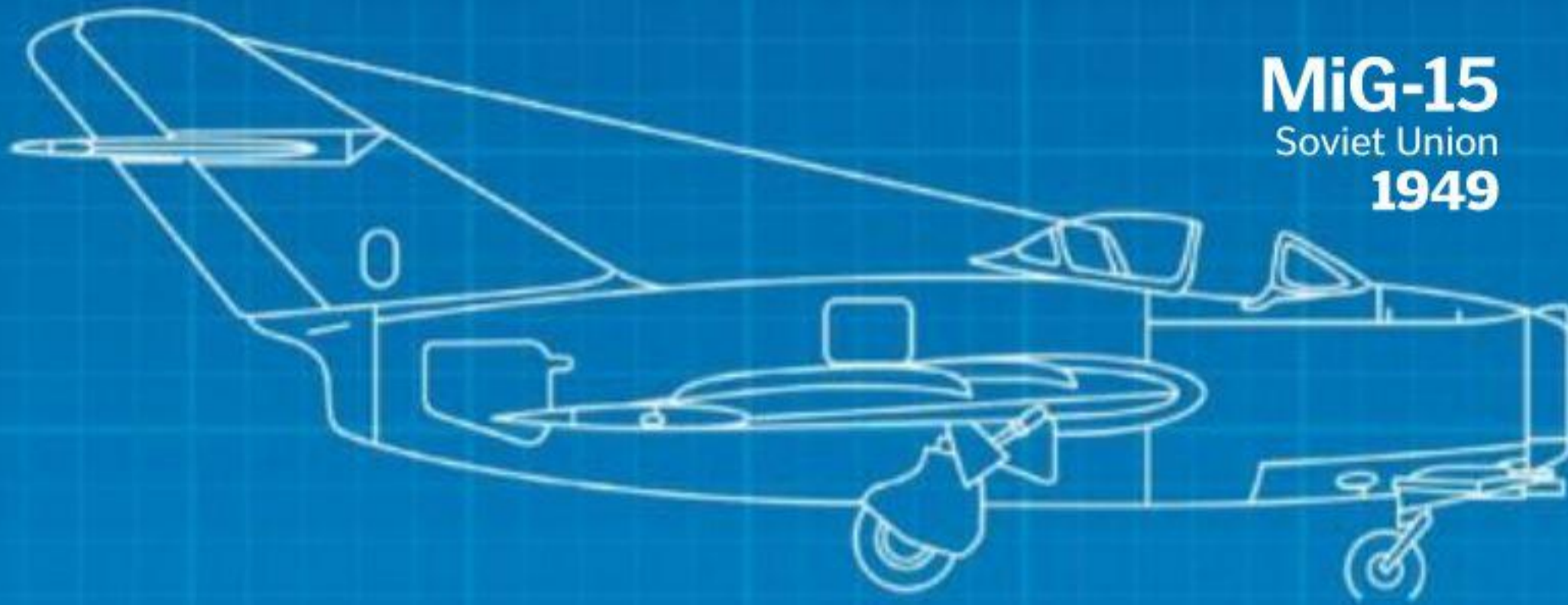

MiG-15
Soviet Union
1949



Supermarine Spitfire
UK
1936

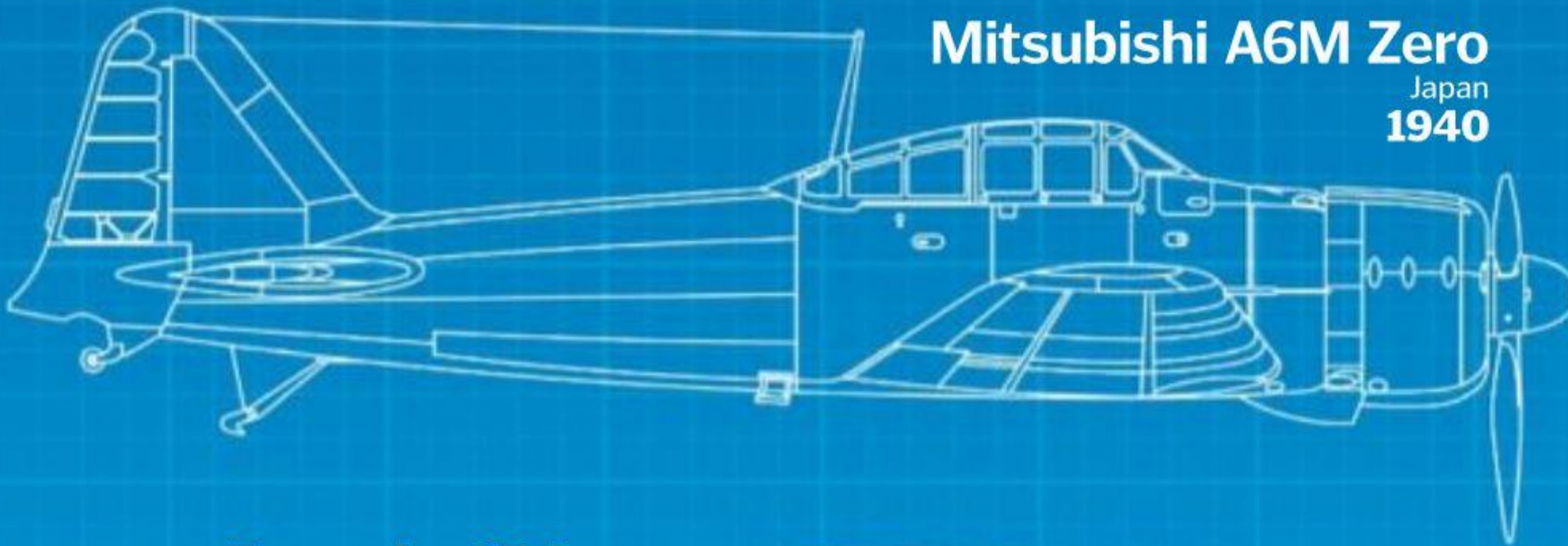

Mitsubishi A6M Zero
Japan
1940



Sopwith Triplane
UK
1916



Tornado GR4
UK, Italy, Germany
1979



Hawker Tempest
UK
1944

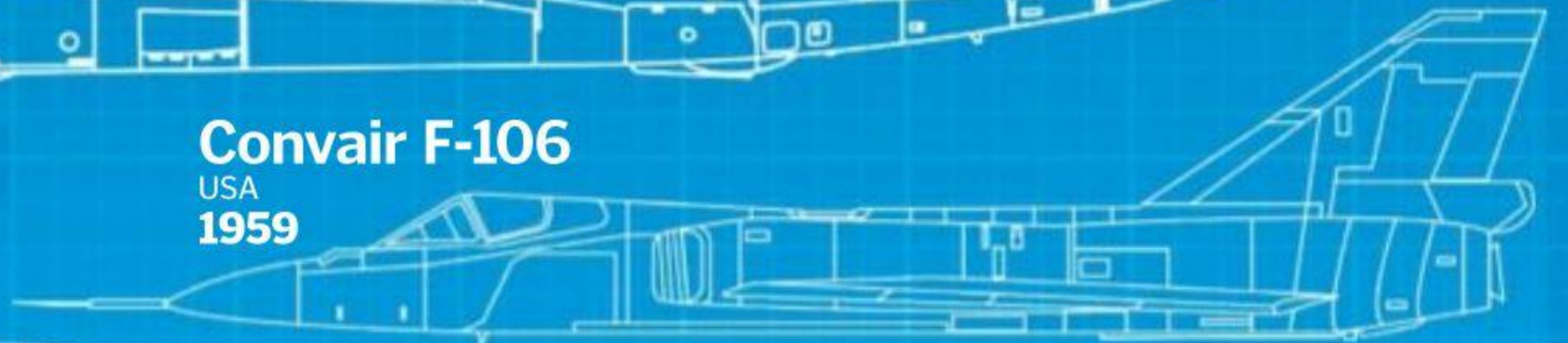

Convair F-106
USA
1959



Yakovlev Yak-1
Soviet Union
1940



F-15 Eagle
USA
1976

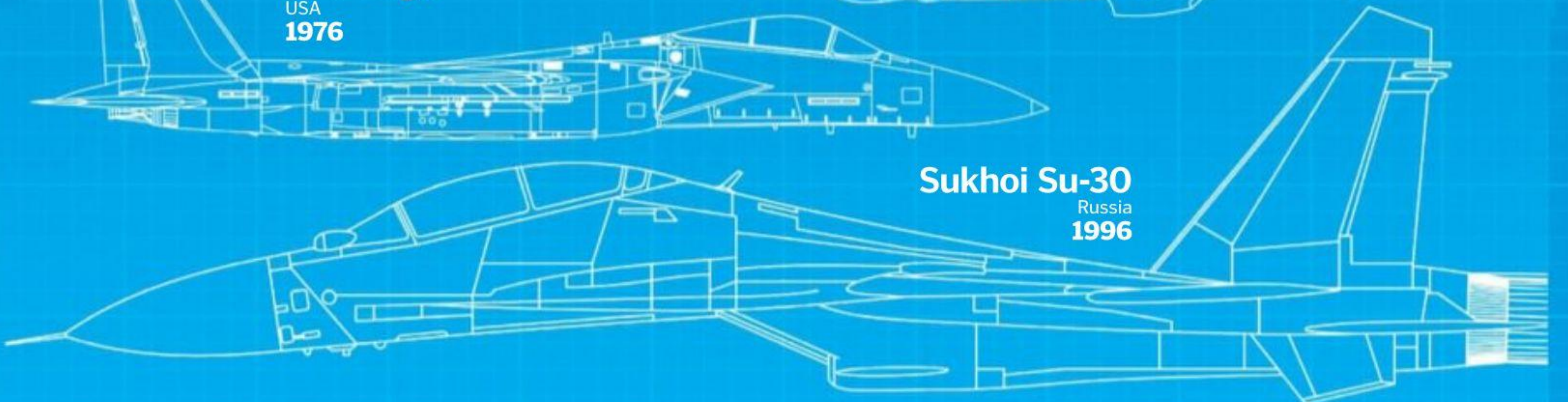

Sukhoi Su-30
Russia
1996

DID YOU KNOW? The F-100 Super Sabre was the first-ever US fighter plane to achieve supersonic speeds

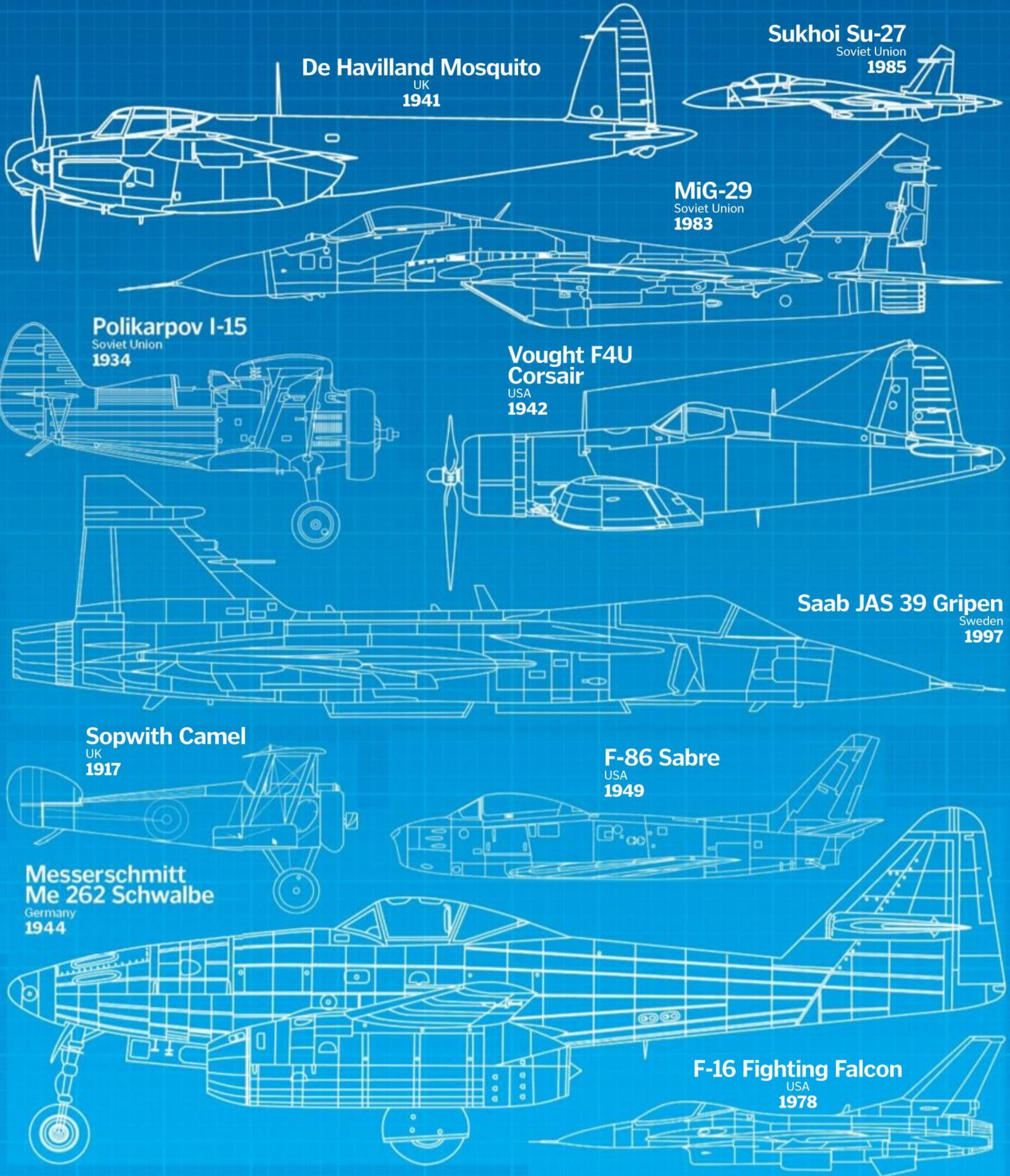

De Havilland Mosquito
UK
1941

Sukhoi Su-27
Soviet Union
1985

MiG-29
Soviet Union
1983

Polikarpov I-15
Soviet Union
1934

Vought F4U Corsair
USA
1942

Saab JAS 39 Gripen
Sweden
1997

Sopwith Camel
UK
1917

F-86 Sabre
USA
1949

Messerschmitt Me 262 Schwalbe
Germany
1944

F-16 Fighting Falcon
USA
1978



HOW IT WORKS

MILITARY AIRCRAFT

100 years of fighter planes

Evolution of the fighter plane

How the old war dogs of the skies reached new heights in their time

Almost as soon as we were able to fly, we have been inventing new ways to destroy one another in the air. Aerial combat has come a long way from pilots leaning out of their cockpits and taking pot shots at one another with pistols.

War may be hell, but it has also been the ideal breeding ground for rapid growth in aviation technology. Certain milestones stand out that have shaped the modern military craft we know today; retractable landing gear, enclosed cockpits, internal weapons systems, jet engines, ejector seats, heads-up displays and more.

Here, two landmark aircraft show off their innovative features, giving a sense of how they took new technology to battle.

Grumman F-14A Tomcat

A cat with formidable claws-in the shape of sidewinder missiles and cutting-edge avionics

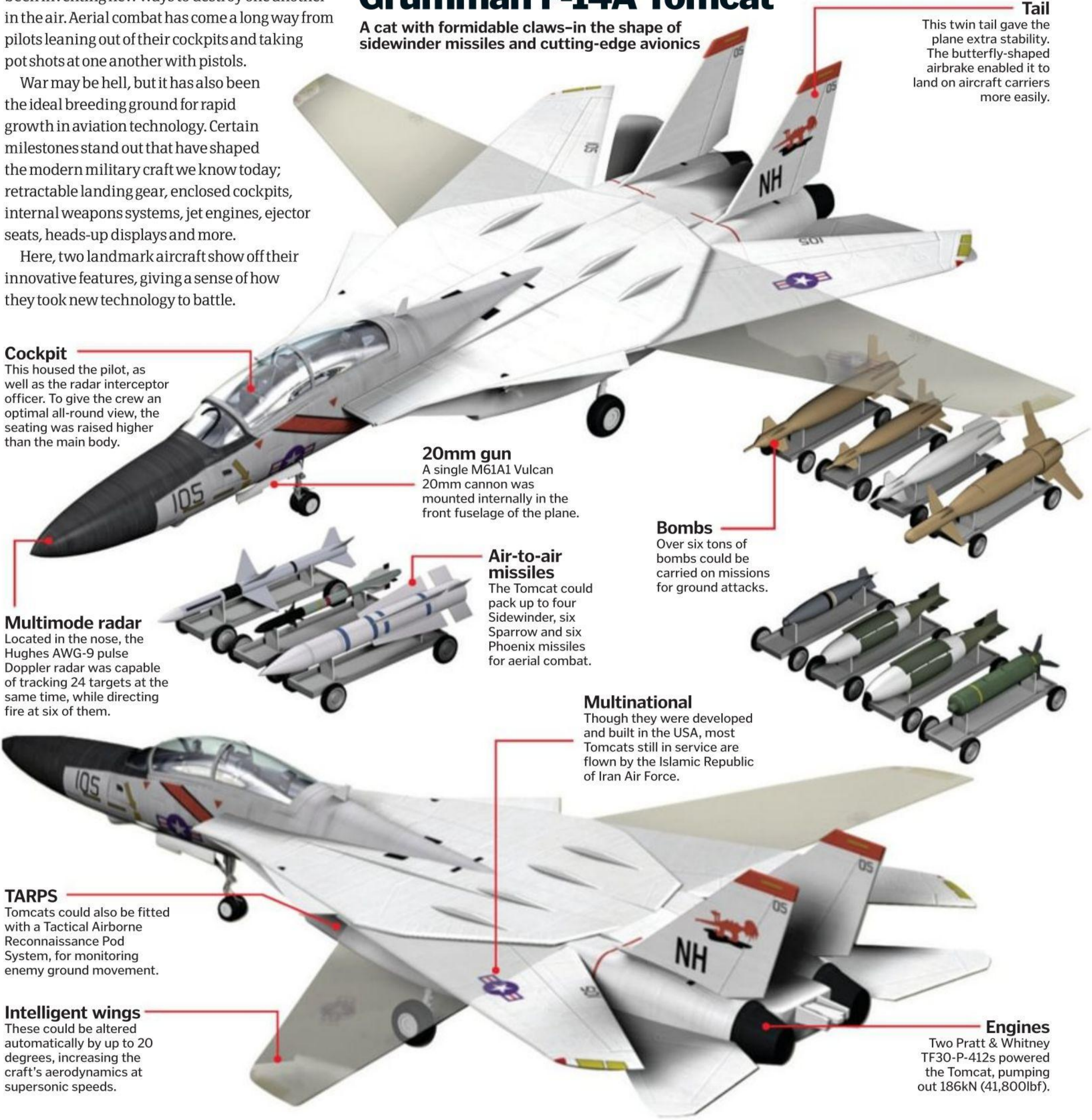

Cockpit

This housed the pilot, as well as the radar interceptor officer. To give the crew an optimal all-round view, the seating was raised higher than the main body.

Multimode radar

Located in the nose, the Hughes AWG-9 pulse Doppler radar was capable of tracking 24 targets at the same time, while directing fire at six of them.

TARPS

Tomcats could also be fitted with a Tactical Airborne Reconnaissance Pod System, for monitoring enemy ground movement.

Intelligent wings

These could be altered automatically by up to 20 degrees, increasing the craft's aerodynamics at supersonic speeds.

20mm gun

A single M61A1 Vulcan 20mm cannon was mounted internally in the front fuselage of the plane.

Air-to-air missiles

The Tomcat could pack up to four Sidewinder, six Sparrow and six Phoenix missiles for aerial combat.

Bombs

Over six tons of bombs could be carried on missions for ground attacks.

Multinational

Though they were developed and built in the USA, most Tomcats still in service are flown by the Islamic Republic of Iran Air Force.

Engines

Two Pratt & Whitney TF30-P-412s powered the Tomcat, pumping out 186kN (41,800lbf).

Tail

This twin tail gave the plane extra stability. The butterfly-shaped airbrake enabled it to land on aircraft carriers more easily.

DID YOU KNOW? The SR-72, successor to the SR-71 Blackbird, is under development in an attempt to reach Mach 6

Messerschmitt Bf 109

This scourge of the skies dominated the battles over early WWII Europe

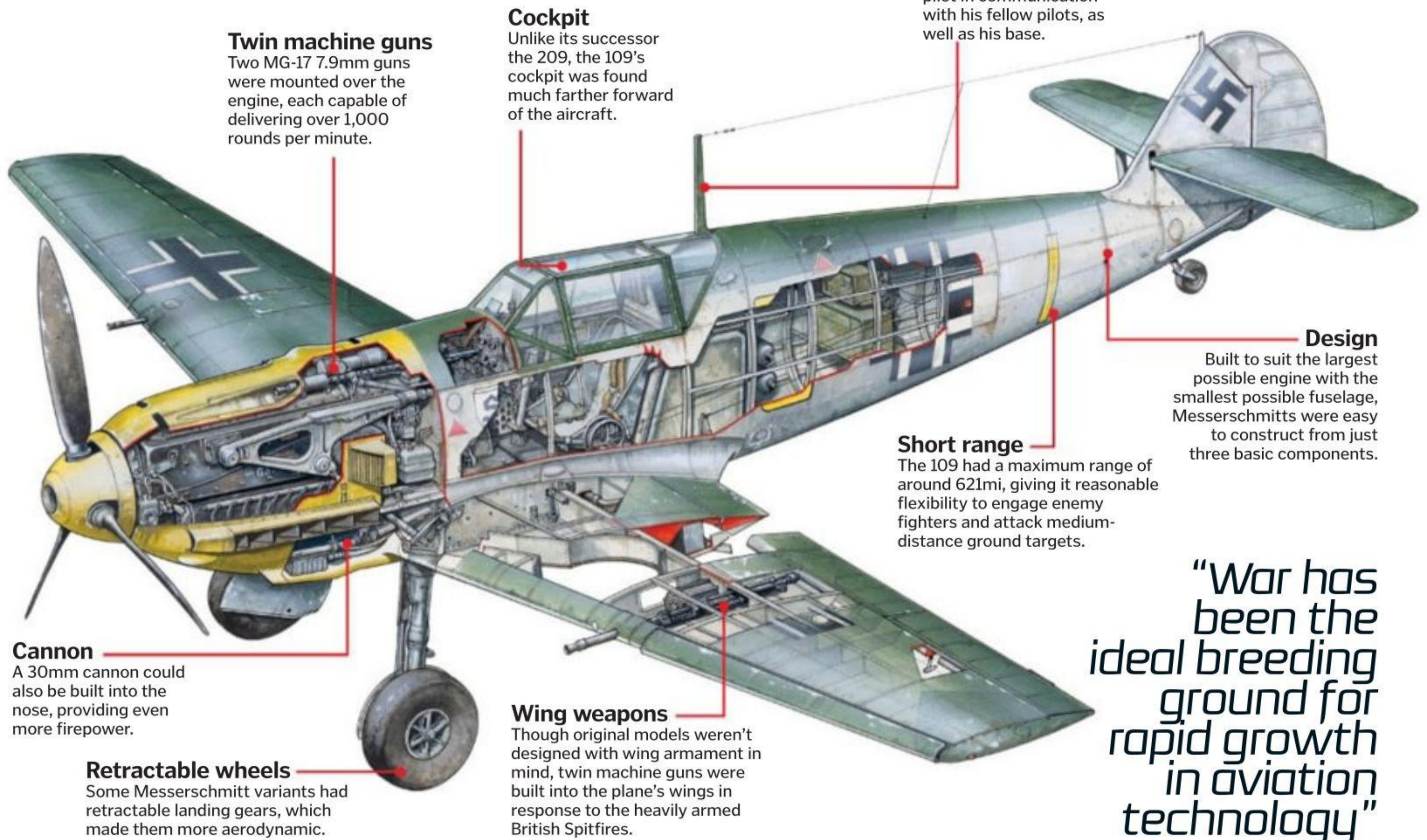

Twin machine guns
Two MG-17 7.9mm guns were mounted over the engine, each capable of delivering over 1,000 rounds per minute.

Cockpit
Unlike its successor the 209, the 109's cockpit was found much farther forward of the aircraft.

Antenna
A high-frequency antenna, connected to a FuG 16Z radio, kept the pilot in communication with his fellow pilots, as well as his base.

Design
Built to suit the largest possible engine with the smallest possible fuselage, Messerschmitts were easy to construct from just three basic components.

Short range
The 109 had a maximum range of around 621mi, giving it reasonable flexibility to engage enemy fighters and attack medium-distance ground targets.

“War has been the ideal breeding ground for rapid growth in aviation technology”

Cannon
A 30mm cannon could also be built into the nose, providing even more firepower.

Retractable wheels
Some Messerschmitt variants had retractable landing gears, which made them more aerodynamic.

Wing weapons
Though original models weren't designed with wing armament in mind, twin machine guns were built into the plane's wings in response to the heavily armed British Spitfires.

The future of warplanes

With the increasing use of unmanned drones to target and monitor enemy positions and combatants, it has been suggested that traditional fighter jets could eventually lose any purpose in future warfare. In 2013 the Northrop Grumman X-47B prototype unmanned aircraft was the first of its kind to perform a carrier-launch and recovery, signalling a possible future of unmanned strike-bomber aircraft. Boeing's QF-16s—retired F-16 jets modified to be controlled remotely—are now regularly used for aerial target training. While these pilotless jets are used as real-life targets to test missile systems, they demonstrate just how accurate remote flight is becoming.

Both government and industry leaders have admitted that future military aircraft will have to be more closely integrated with artificial intelligence, even with suggestions that manned jets may work alongside pilotless craft. Studies by the Defense Advanced Research Projects Agency (DARPA) have revealed that drones operate more effectively in packs, prompting further research into how drones could work with one another, rather than rely solely on human controllers in combat scenarios. Even before the fifth generation of fighter jets become widely available, including the F-35 Lightning II and Shenyang J-31, world governments are already looking at cost-effective, as well as cutting-edge solutions for the sixth generation of military aeronautics.



The F-35 Lightning II is currently the fifth-generation of fighter aircraft for several global air forces and navies



HOW IT WORKS

MILITARY AIRCRAFT

The Supermarine Spitfire

Supermarine Spitfire

Arguably the most iconic fighter aircraft of World War II, the RAF Spitfire to this day is championed for its prowess, grace and versatility

Propeller

Original Spitfires had wooden propellers, these were later replaced with variable-pitch propellers, and more blades were added as horsepower increased.

Airframe

The aircraft's airframe was an amalgamation of a streamlined semi-single piece of aluminium alloy with an enclosed cockpit, allowing increased responsiveness and ease of flight.

This video still from a gun camera shows the tracers



Rolls-Royce Vee-12 engine

The Spitfire utilized two variants of Rolls-Royce engine during its production life span, the six-gallon Merlin and the 8.2-gallon Griffon.

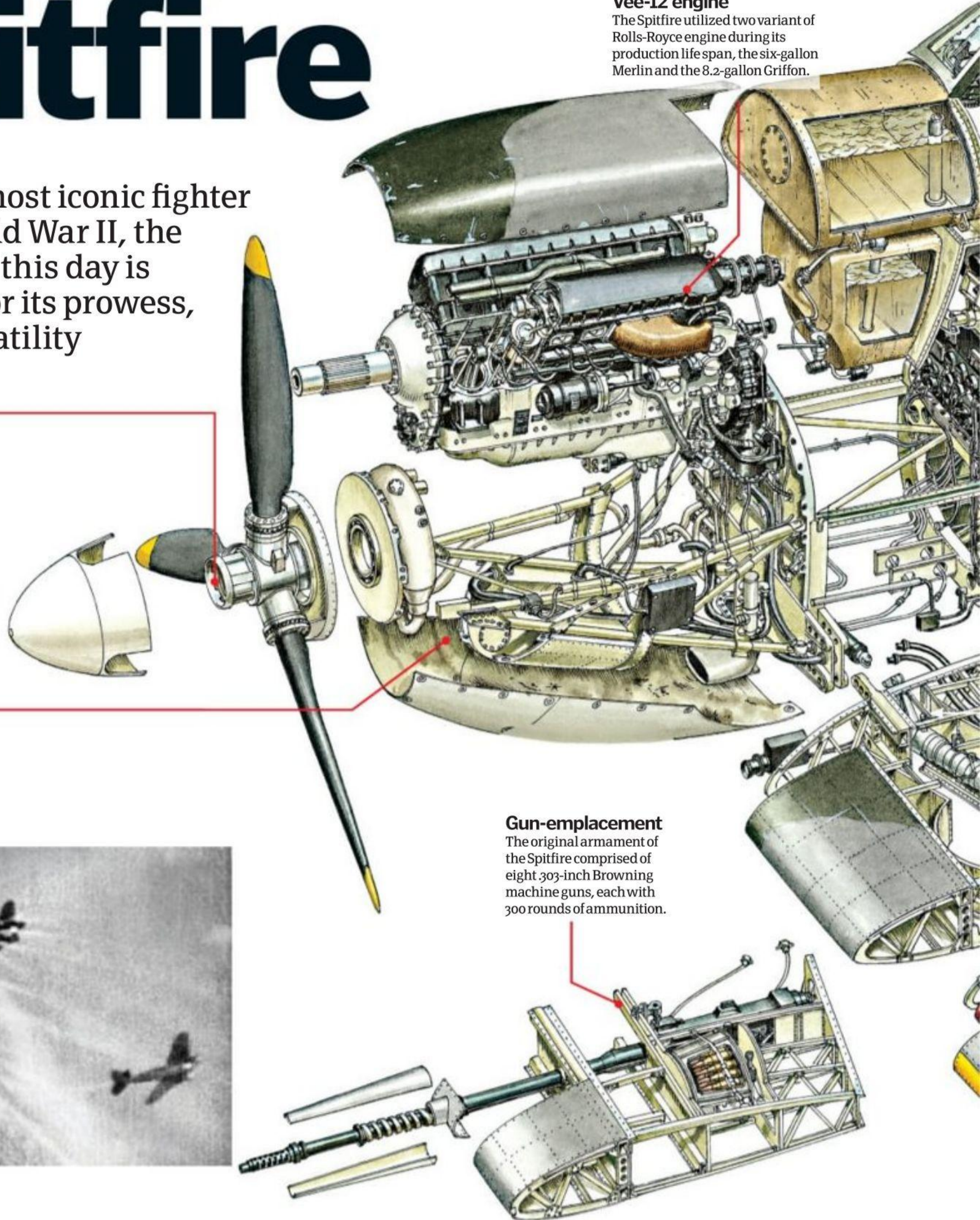

Gun-emplacement

The original armament of the Spitfire comprised of eight .303-inch Browning machine guns, each with 300 rounds of ammunition.

DID YOU KNOW? By 1939, approximately ten per cent of all Spitfires had been lost as a result of training accidents

Fully enclosed cockpit

The benefits of a fully enclosed cockpit were numerous, most notably though it improved the Spitfire's aerodynamics.

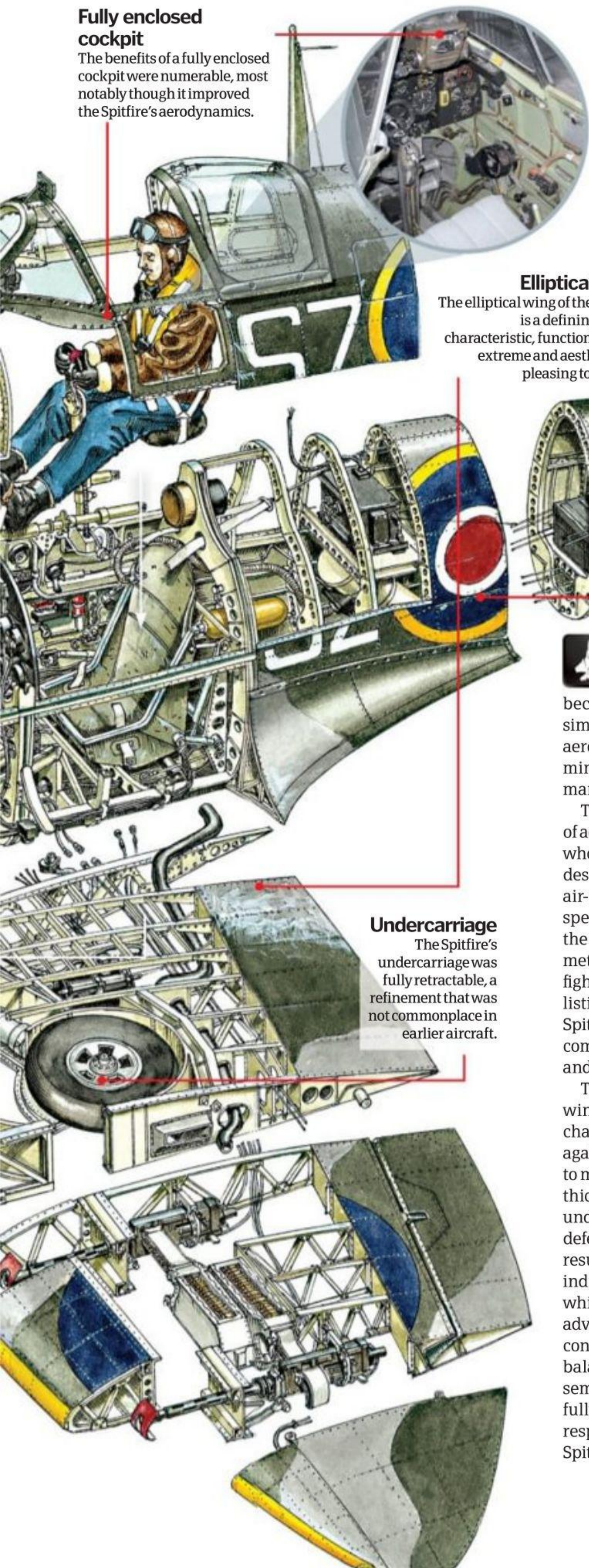

Elliptical wing

The elliptical wing of the Spitfire is a defining design characteristic, functional to the extreme and aesthetically pleasing to the eye.

Undercarriage

The Spitfire's undercarriage was fully retractable, a refinement that was not commonplace in earlier aircraft.

Inside the Spitfire

What made this aircraft so spectacular?

Fuselage

The fuselage of the Spitfire was constructed from toughened aluminium alloy, composing of 19 individual frames.



Designed in the technologically fervent and innovatory melting pot of World War II, the Supermarine Spitfire became the fighter plane of the times. With its simple lines, elegant frame and superb aerodynamics, the Spitfire was to live on in the minds of generations during the war and for many decades to come.

The Supermarine Spitfire was the brainchild of aeronautical engineer Reginald Mitchell, who led a dedicated and talented team of designers. Originally planned as a short-range air-defense fighter, the Spitfire was built for speed and agility, traits that it was to need in the explosive dogfights it was to partake in as it met enemy fighters and bombers. Building a fighter plane, though, is more complex than listing desirable traits however, and the Spitfire's construction is a balletic series of compromises between weight, aerodynamics and firepower.

The frame of a Spitfire with its elliptical wings is one of its most defining characteristics, casting a distinctive silhouette against the sky. The ellipse shaping was used to minimize drag while having the necessary thickness to accommodate the retracted undercarriages and the guns required for self defense. A simple compromise that had the resulting benefit of having an incredibly individual shape. In contrast, the airframe—which was influenced by exciting new advances in all metal, low-wing plane construction—was a complex and well-balanced amalgamation of a streamlined semi-single piece of aluminium alloy and a fully enclosed cockpit. This allowed unrivalled responsiveness and ease of flight, making the Spitfire a favourite for pilots.

Arguably, the other most defining and success-inducing element of the Spitfire was its engine, which took on the form of the Rolls-Royce Merlin and Griffon engines. Planned by a board of directors at Rolls-Royce who realized that their current Vee-12 engine was topping out at 700hp and that a more powerful variant would be needed, first the Merlin and later the Griffon engines were designed. The Merlin at first delivered 790hp, short of the 1,000hp goal set in its design brief, however this was to increase to 975hp in a few years. The Griffon then built upon the success of the Merlin, delivering at the climax of its advancement a whopping 2,035hp. These engines were to prove tantamount to the airframe and wing designs in the dominance of the Spitfire.

Despite its origins lying in short-range home defense, the Spitfire was to prove so versatile and successful that it was quickly adapted for a wide variety of military purposes. Many variants were created, including designs tailored for reconnaissance, bombing runs, high-altitude interception and general fighter-bomber operations. The most notable derivative, however, was the multi-variant Seafire, specially designed for operation on aircraft carriers with the added ability to double-fold its wings for ease of storage.

Considering the place in history that the Spitfire holds—a fighter-bomber aircraft that bridged the gap between the age of the propeller engine to that of the jet—the fact that they are still collected (with an average cost of \$1.7 million) and flown today is unsurprising. The Spitfire is a timeless piece of engineering that shows some of the most creative and advanced efforts in military history.



Lancaster bomber

Famed for its prowess and entrenched in popular culture by The Dam Busters film of 1955, the Lancaster bomber played a vital role in securing an Allied victory in World War II

 Arguably one of the most famous heavy bombers of World War II, the Avro-built Lancaster bomber undertook some of the most dangerous and complex missions yet encountered by the RAF. Primarily a night bomber but frequently used during the day too, the Lancasters under Bomber Command flew some 156,000 sorties during the war, dropping 609,000 tons of bombs. Among these bombs was the famous 'bouncing bomb' designed by British inventor Barnes Wallis, a payload that would lead the Lancaster to remain famed long after 1945. We take a look inside a Avro Lancaster to see what made it so successful.

Lancaster bombers dropped 609,000 tons of bombs



Crew

Due to its large size, hefty armament and technical complexity, the Lancaster bomber had a crew of seven. This included: a pilot, flight engineer, navigator, bomb aimer, wireless operator, mid-upper and rear gunners. Many crew members from Lancasters were awarded the Victoria Cross for their heroic actions in battle, a notable example being the two awarded after a daring daytime raid on Augsburg, Germany.

Inside a Lancaster bomber



Turrets

As standard the Lancaster bomber was fitted with three twin 7.7mm turrets in the nose, rear and upper-middle fuselage. In some later variants of the Lancaster the twin 7.7mm machine guns were replaced with 12.7mm models, which delivered more power. The rear and upper-middle turrets were staffed permanently by dedicated gunners, while the nose turret was staffed periodically by the bomb aimer when caught up in a dogfight.



Bomb bay

The bomb bay could carry a great payload. Indeed, the bay was so spacious that with a little modification it could house the massive Grand Slam "earthquake" bomb, a 22,000lb giant that when released would reach near sonic speeds before penetrating deep into the Earth and exploding.

Fuselage

The Lancaster was designed out of the earlier Avro Type 683 Manchester III bomber, which sported a three-finned tail layout and was similar in construction. While the overall build remained similar the tri-fin was removed in favour of a twin-finned set up instead. This is famously one of only a small number of design alterations made to the bomber, which was deemed to be just right after its test flights.

5 TOP FACTS LANCASTER BOMBER

High calibre

1 While 7.7mm machine guns were standard on Lancaster bombers, selective later variants were fitted with twin 12.7mm turrets in both tail and dorsal positions.

Slam-dunk

2 Lancaster bombers often had their already-large bomb bays modified in order to carry the monumental 22,000-pound Grand Slam "earthquake" bombs.

Busted

3 A selection of bombers became famous after Operation Chastise, a mission to destroy German dams in the Ruhr Valley, the inspiration for the film *The Dam Busters*.

Collateral

4 Between 1942 and 1945 Lancaster bombers flew 156,000 sorties and dropped approximately 609,000 tons of bombs on military and civilian targets.

Black label

5 The lager company Carling used footage of Lancaster bombers to create a parody of *The Dam Busters* in which a German soldier catches the bouncing bombs.

DID YOU KNOW? A single Lancaster bomber cost £62,000 in 1942, roughly \$1.8 million in today's currency

Over 7,000 bombers were built



Powerplant

The Lancaster bomber was powered by four Rolls-Royce Merlin V12 engines. These were chosen by the Lancaster's chief designer Roy Chadwick due to their reliability, as the incumbent bomber—the Avro Manchester—had adopted the Rolls-Royce Vulture and had been troubled by engine failure consistently when in service.



The bouncing bomb

One of the most famous parts of the Lancaster's heritage is its role in carrying and releasing the 'bouncing bomb' payload, as glamorized in the 1955 film *The Dam Busters*. The bomb was designed by Barnes Wallis—who was also the creator of the Grand Slam and Tallboy bombs—and was special in its ability to bounce along the top of a surface of water, much akin to skimming a stone. It was designed to counteract and evade German defenses below and above the waterline, allowing Allied forces to target German hydroelectric dams and floating vessels.

In May 1943 the bouncing bombs were utilized in Operation Chastise, an Allied mission to destroy German dams in the Ruhr Valley. The aircraft used were modified Avro Lancaster Mk IIIs, which had much of their armour and central turret removed in order to accommodate the payload. Despite eight of the Lancasters being lost during the operation, as well as the lives of 53 crew, a small number of bouncing bombs were released and they caused two dams to be breached, one to be heavily damaged and 1,296 German civilians to be killed.



That's a real dam buster...



The statistics...

Lancaster bomber

Crew: 7
Length: 69ft
Wingspan: 102ft
Height: 20ft
Weight: 63,934lb
Powerplant: 4 x Rolls-Royce Merlin XX V12 engines
Max speed: 280mph
Max range: 3,000mi
Max altitude: 26,772ft
Armament: 8 x .77mm Browning machine guns; bomb load of 13,889lb



"The Sea Harrier squadron achieved this due to their high maneuverability"

Sea Harrier

Before being retired in 2006, the Sea Harrier dominated the subsonic jet fighter field, changing the dynamics and operation of the strike fighter role forever

 The British Aerospace Sea Harrier was the purpose-built naval variant of the Hawker Siddeley Harrier strike fighter, an aircraft famed for its vertical take-off and landing (VTOL) and short take-off and vertical landing (STOVL) capabilities. It worked by adopting the revolutionary single-engine thrust vectoring technology of the regular harrier (see 'Degrees of power' boxout) and partnering it with a modified fuselage—to allow the installation of the superb Blue Fox radar system—bubble-style canopy (larger, allowing greater visibility) and a significantly improved arms load out.

These factors, partnered with the aircraft carrier's ability to launch the aircraft from its ski-jump, allowed the Sea Harrier to perform to a high standard at sea, carrying more weight, detecting enemies sooner and taking them down quickly and efficiently. This was demonstrated most vividly during the Falklands War of 1982, when 28 Sea Harriers operating off British aircraft carriers shot down 20 Argentine aircraft in air-to-air combat without suffering a single loss. The Sea Harrier squadron achieved this due to their high manoeuvrability and tactics while in dogfights—for example, braking/changing direction fast by vectoring their thrust nozzles while in forward flight—as well as their pilots' superior training and early warning/detection systems.



Thrust vectoring
To achieve VTOL capabilities, the Sea Harrier's engine thrust was directed through four vectoring nozzles, which could rotate through 98.5 degrees from vertically downwards to horizontal.

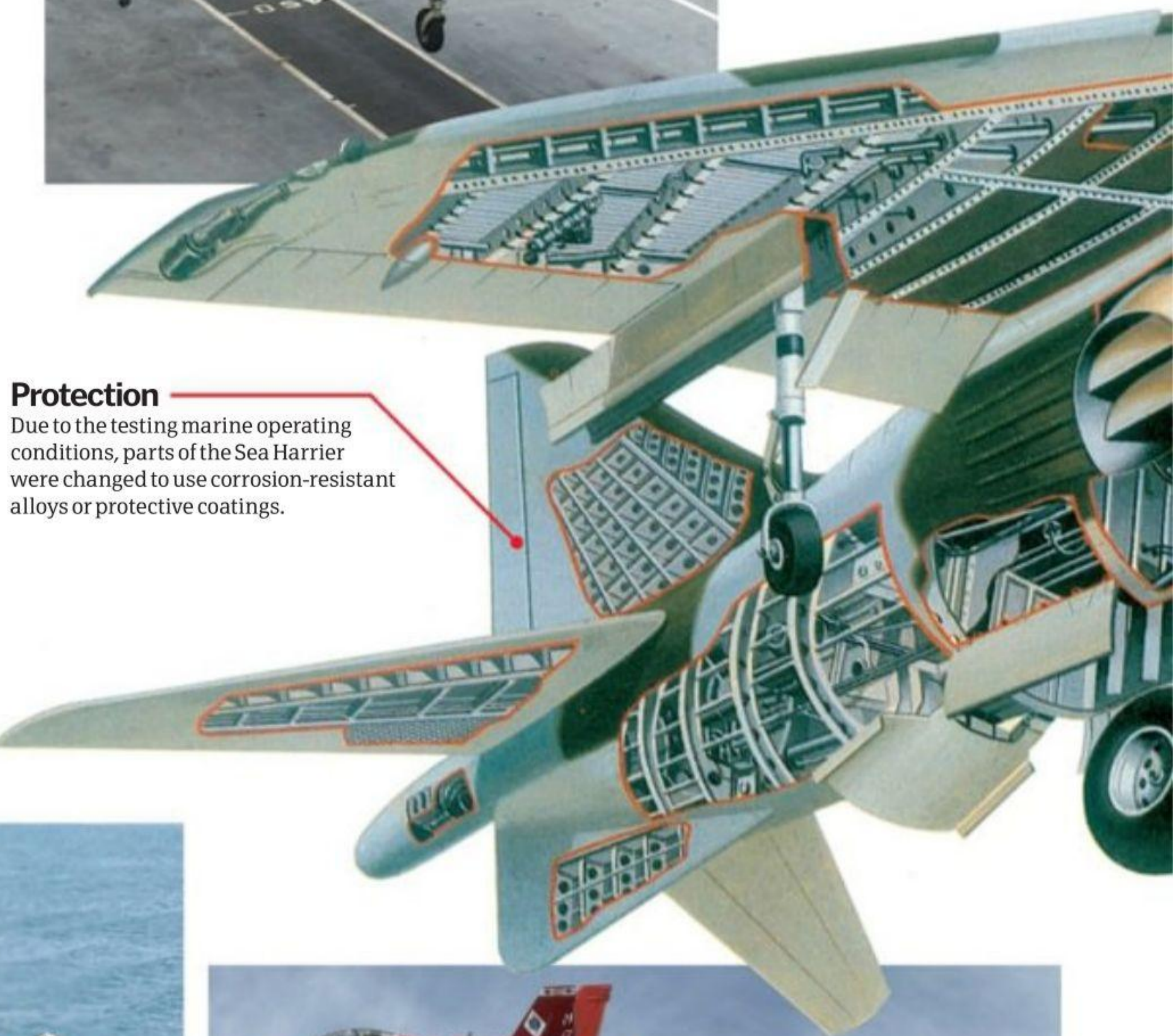

Protection
Due to the testing marine operating conditions, parts of the Sea Harrier were changed to use corrosion-resistant alloys or protective coatings.

Second-generation Sea Harriers on board an aircraft carrier in the Persian Gulf



Two Indian Navy Sea Harriers fly alongside a US Navy F/A-18F Super Hornet

5 TOP FACTS HARRIERS

Old boy

1 The Sea Harrier was in service for a total of 28 years, from August 1978 to March 2006. The second-generation Sea Harrier FA2 was introduced in April 1993.

Post-colonial

2 The only other international operator of the Sea Harrier is actually India, who use their own FRS51 variant armed with R550 Magic air-to-air missiles.

Invincible

3 The first ever Sea Harrier confirmed as operational launched off the Invincible class aircraft carrier HMS Invincible in 1981, a purpose-designed VTOL/STOL carrier.

Vixen

4 The second-generation Sea Harrier, the FA2, featured the Blue Vixen radar, the predecessor that formed the basis of the system used in the Eurofighter Typhoon.

Forgetful

5 The second-generation Sea Harrier was also the first British aircraft to be armed with the US AIM-120 AMRAAM, a fire and forget high-explosive air-to-air missile.

DID YOU KNOW? During the Falklands conflict the Sea Harrier shot down 20 Argentine aircraft with no air-to-air losses

Powerplant

The Sea Harrier was fitted with the Rolls-Royce Pegasus 11 turbofan, an engine capable of producing 21,495 pounds of force. This delivered a massive amount of power, which while not taking the jet to supersonic speeds did allow it to lift off vertically, spreading the output over multiple outlets positioned over the aircraft.

Crew

The first-generation Sea Harrier FRS1 and second-generation FA2 were both single-seat fighters. However, the T4N and T60 varieties were built with two seats as they were used for land-based pilot conversion training.

Electronics

Equipped according to generation by the Ferranti Blue Fox or Blue Vixen radars respectively, the Sea Harrier carried at the time some of the most advanced military radar systems in the world. It is suggested by military historians that the Blue Fox radar was one of the key reasons why the Sea Harrier performed so successfully in the Falklands War.

Some Harriers were fitted with the AIM-120 AMRAAM missile



Armament

As a strike fighter the Sea Harrier was equipped with a broad arsenal, ranging from conventional, unguided iron bombs—including WE.177 nuclear options—to rockets and laser-guided missiles such as the AIM-9 Sidewinder. The second generation FA2 was famously equipped with deadly AIM-120 AMRAAM air-to-air, fire and forget missiles.

The statistics...



Sea Harrier FA2

- Crew:** 1
- Length:** 47ft
- Wingspan:** 25ft
- Height:** 12ft
- Max take-off weight:** 26,235lb
- Powerplant:** 1 x Rolls-Royce Pegasus turbofan (21,500lbf)
- Max speed:** 735mph
- Combat radius:** 621mi
- Max range:** 2,237mi
- Max service ceiling:** 52,493ft
- Guns:** 2 x 30mm ADEN cannon pods (100 rounds per cannon)
- Rockets:** 72 SNEB 68mm rockets
- Missiles:** AIM-9 Sidewinder, AIM-120 AMRAAM, R550 Magic, ALARM anti-radiation missile, Martel missile, Sea Eagle anti-ship missile
- Cost:** \$18 million

Degrees of power

Giving the Sea Harrier lift off

The real showpiece and reason for the lengthy success of the Sea Harrier was its utilisation of the Harrier's revolutionary Pegasus engine partnered with thrust vectoring nozzles. These nozzles could be rotated by the pilot through a 98.5-degree arc, from the conventional aft (horizontal) positioning as standard on aircraft, to straight down, allowing it to take off and land vertically as well as hover, to forward, allowing the Harrier to

drift backwards. All nozzles were moved by a series of shafts and chain drives, which insured that they operated in unison (crucial for maintaining stability) and the angle and thrust was determined in-cockpit by the pilot.

This flexibility of control and placement meant that the Sea Harrier was highly maneuverable while in the air and could be landed and launched from almost anywhere.

The Sea Harrier's vectoring nozzle in aft position





HOW IT WORKS

MILITARY AIRCRAFT

All-weather jet fighter

"It was famed for its ability to pass the sound barrier, going supersonic in a shallow dive"

Sea Vixen

Sporting one of the most notable post-war aircraft designs, the de Havilland Sea Vixen was a fearsome all-weather jet fighter, capable of taking its pilots supersonic and delivering a titanic amount of next-generation firepower



The first British fighter to be fitted purely with missiles, rockets and bombs—rather than the heavy calibre machine guns relied upon in WWI and WWII—the Sea Vixen was a first generation jet fighter employed by the Fleet Air Arm of the Royal Navy. It was famed for its ability to pass the sound barrier, going supersonic when in a shallow dive (hitting a top speed of 690mph) and saw action in multiple missions in the Middle East and Africa during the 1960s and 70s.

Designed to be deployed from aircraft carriers as an all-weather fighter and high-speed reconnaissance jet, the Sea Vixen worked by partnering the reinforced twin-boom tail layout as seen on its predecessors the Sea Vampire and Sea Venom, with the colossal power generated by twin Rolls-Royce Avon 208 turbojet engines, each capable of delivering 7,500lb of thrust. This gave the Vixen massive speed, a range of 600 miles—the twin-boom layout allowed for more fuel tanks—and a flexibility to engage targets at sea, on land and in the air, as well as conduct lengthy patrols.

The armament of the Sea Vixen was revolutionary for the time. With six hardpoints

(areas that weapons can be mounted on) capable of being fitted with a selection of Firestreak air-to-air missiles, which sported annular blast fragmentation warheads, SNEB rocket pods with 68 unguided explosive-tipped rockets each, and whopping 500-pound air-to-ground bombs. Detection of targets was also state-of-the-art, the Sea Vixen was fitted with the GEC Al.18 Air Interception radar, which gave the jet great strategic vision even at night or in particularly poor visibility conditions.

By 2015 only one working Sea Vixen survived in the entire world, which was maintained by Naval Aviation Ltd and operated from Yeovilton, Great Britain. After being declassified as a military aircraft and entered onto the civil register (changing its tag from XP924 to G-CVIX), the aircraft was used for a time as an advertising vehicle for Red Bull before being repainted with its original Fleet Air Arm 899 NAS colours and flying in several demonstrations and air shows across the United Kingdom. Sadly, it took to the skies for the last time in 2017.



© Nigel Lish

Chassis

The Sea Vixen built upon the chassis used in the early de Havilland Sea Vampire, and featured an all-metal construction and swept wings.

Cockpit

The pilot's canopy is offset to the left-hand side of the chassis, while the observer is housed to the right completely ensconced within the fuselage, only capable of gaining access through a flush-fitting top hatch.



The Red Bull plane repainted in its original livery

5 TOP FACTS SEA VIXEN

Disaster

1 On September 6, 1952, a prototype Sea Vixen disintegrated in mid-air at the Farnborough Airshow while attempting to break the sound barrier, killing 31 people.

Breaker

2 One of the crew killed at the Farnborough Airshow was John Derry, the first British person to exceed the speed of sound in a de Havilland DH 108 in September 1948.

Home

3 One of the only remaining Sea Vixens capable of flight was kept at Bournemouth International Airport in Dorset, until an accident on the runway in 2014.

Merger

4 The Sea Vixen was produced by the de Havilland company, but post merger with the Hawker Siddeley aerospace group it was renamed the Hawker Siddeley Sea Vixen.

Vintage

5 De Havilland Aviation is a company that specializes in acquiring and reconditioning most military aircraft. You can find out more at www.dehavillandaviation.com

DID YOU KNOW? The Sea Vixen FAW. 1 was equipped to carry Britain's first tactical nuclear bomb, Red Beard, in the 1960s

The Sea Vixen could reach speeds of up to 690mph



Twin-boom

Another similarity shared with the Sea Vampire was the Sea Vixen's twin boom tail layout, which aided strength and rigidity when traveling at sub-sonic and near sub-sonic speeds.

The statistics...



Sea Vixen

Crew: 2
Length: 55ft
Wingspan: 51ft
Empty weight: 27,995lb
Loaded weight: 41,579lb
Powerplant: 2 x Rolls-Royce Avon Mk.208 turbojets
Max speed: 690mph
Range: 790mi
Service ceiling: 48,000ft
Armament: 4 x Matra rocket pods with 18 SNEB 68mm rockets each, 4 x Red Top air-to-air missiles, 2 x 500lb bombs

Powerplant

It was powered by two Rolls-Royce Avon 208 turbojet engines, each capable of producing 7,500lb of thrust. This massive power allowed the jet to go supersonic in a shallow dive.

Armament

The Vixen had six hardpoints upon which it could carry a combination of Matra rocket pods with 18 SNEB 68mm rockets each, Firestreak air-to-air missiles and 500lb high-explosive bombs.



A Sea Vixen with Red Bull advertising



HOW IT WORKS

MILITARY AIRCRAFT

World's fastest helicopter

"Since the first flight the Lynx has been continually upgraded and developed"

Westland Lynx

A record breaker and for over 40 years—can anything beat the Lynx?



The Westland Lynx forms the backbone of the British Army and Navy helicopter forces. Entering military service in 1978, it had already set world speed records during testing. Introduced as a utility helicopter in 1971, the Lynx is a twin gas turbine-powered, two-pilot aircraft, with advanced control systems, a four-blade, semi-rigid rotor and, thanks to the fundamental stability and unrivalled agility of the basic airframe, it has performed in almost every role imaginable.

From troop transport, armed escort and anti-tank warfare with the Army Air Corps, to anti-submarine warfare and maritime attack with the Fleet Air Arm, and in many similar roles across the globe, the Lynx is used by the militaries of over a dozen countries worldwide.

This helicopter is used as an airborne command post, a fire support platform, as well as for search and rescue, casualty evacuation, plus many specialist roles including anti-pirate and border patrol. The British Army and Navy also have display teams that use the exceptional agility of the Lynx to amaze the crowds at air shows.

Since its first flight, over four decades ago, the Lynx has been continually upgraded and developed, ensuring it's always at the forefront of technology, as demonstrated by the most current variant, the Super Lynx. Army models kept the traditional landing 'skids' until only recently, when they adopted the tricycle-wheeled undercarriage used by the Navy to aid ground handling.

Improvements in navigation, communication and radar systems in Navy derivatives have ensured that British helicopter capability at sea is world leading, while Army versions have similarly demonstrated their ability to evolve with the changing requirements of modern warfare.

The latest variants are excelling on the battlefield, using state-of-the-art weapons and tactics including night-vision-assisted operations. The next generation of Lynx (the Wildcat) is currently undergoing flight testing on land and sea, ensuring many years of continued service.



Central hub

A single-piece titanium forging, the central hub takes all loads imposed by flight, as the blades rotate around it.

Engines

Two Rolls-Royce Gem 41-1 turboshafts producing 835kW (1,120shp) each spin the main rotor through a shared gearbox.

Pilots in control

The two pilots make use of the three-axes stabilisation system to gain a solid weapon launch platform.

Wheels

Unlike other Army Lynx versions, the AH.9 has a Navy-style tricycle undercarriage to help with ground handling.

Lynx AH.9 teardown

The AH.9 variant of the Lynx is used exclusively by the British Army, primarily as a utility vehicle

The statistics...

Westland Lynx AH.9

Length: 50ft

Rotor diameter: 42ft

Height: 12.4ft

Disc area: 1,385ft²

Empty weight: 7,255lb

Max takeoff weight: 11,750lb

Powerplant: 2 x Rolls-Royce Gem 41-1 turboshaft, 835kW (1,120shp) each

Max speed: 201mph

Range: 328mi



© AgustaWestland

5 TOP FACTS WESTLAND LYNX

Unbeatable record?

1 The world helicopter speed record set by G-LYNX still stands over 25 years later. With the latest fast rotorcraft moving away from eligible designs, G-LYNX's record may never be broken.

War veteran

2 The Lynx has proven capabilities in many combat environments, including disabling the Argentine submarine Santa Fe during the Falklands campaign, and sinking several Iraqi ships in the Gulf Wars.

Blow me down

3 Naval versions of the Lynx have the ability to angle the main rotor blades downwards to generate negative lift, pushing the aircraft onto the deck of a ship after landing.

More speed?

4 An even faster variant of the Lynx was proposed but never built. It would not have qualified for a world speed record, though, as it had airplane-like wings beneath the rotor.

Super-strong

5 The key component in the Lynx rotor is a solid titanium hub around which everything spins. This provides the strength needed for both high-speed and high-agility maneuvers.

DID YOU KNOW? The Lynx is one of the few helicopters in the world that can perform advanced aerobatics, including loops

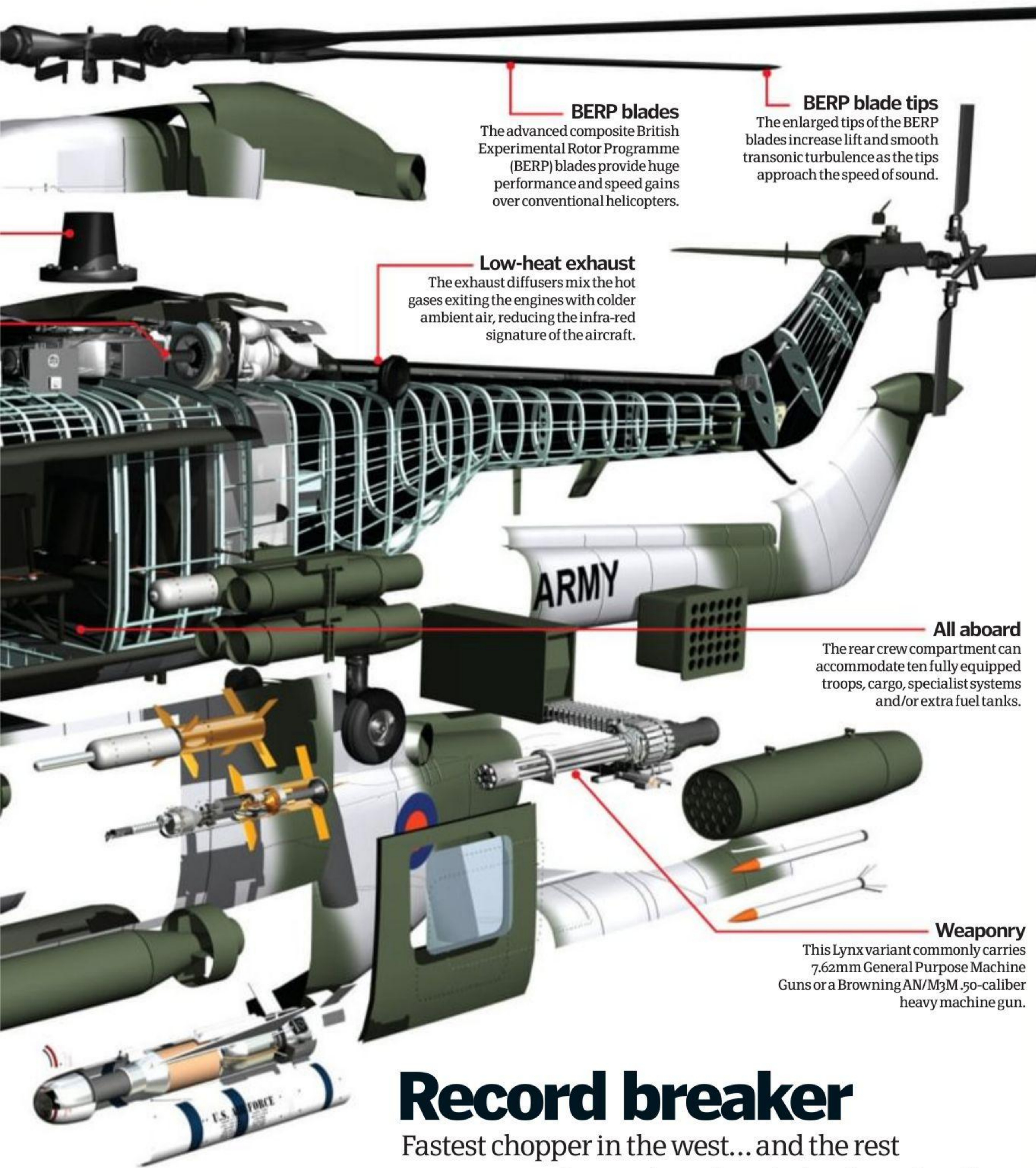

BERP blades
The advanced composite British Experimental Rotor Programme (BERP) blades provide huge performance and speed gains over conventional helicopters.

BERP blade tips
The enlarged tips of the BERP blades increase lift and smooth transonic turbulence as the tips approach the speed of sound.

Low-heat exhaust
The exhaust diffusers mix the hot gases exiting the engines with colder ambient air, reducing the infra-red signature of the aircraft.

All aboard
The rear crew compartment can accommodate ten fully equipped troops, cargo, specialist systems and/or extra fuel tanks.

Weaponry
This Lynx variant commonly carries 7.62mm General Purpose Machine Guns or a Browning AN/M3M .50-caliber heavy machine gun.

Top trumps: MILITARY CHOPPERS



WESTLAND LYNX AH.9

The Lynx is the smallest and lightest aircraft of the three in this roundup, which allows it to operate from small ships. The Lynx can carry more troops and is far more agile than its larger counterparts, but has less power so cannot carry as high a payload or as many weapons.



SIKORSKY SH-60 SEAHAWK

The Seahawk has a huge range advantage over its competitors—almost twice that of the Hind. The common parts it shares with the other aircraft in the Blackhawk family make maintenance and repair highly cost effective. However, it cannot operate from small ship decks, and is not particularly agile.



MIL MI-24 HIND

The Hind is heavily armoured, heavily armed, extremely fast and very powerful. It is not used by the Navy due to its limited range, and its size means it is not very agile. Despite the variety of fearsome weapons that it can carry on its hardpoints, the Hind has often lacked a reliable anti-armour capability.

Record breaker

Fastest chopper in the west... and the rest

In 1972, just one year after its introduction, the Westland Lynx became the world's fastest helicopter when airframe XX153 set a new world speed record over 9.3-mile and 15.5-mile straight courses by flying at an average 200 miles per hour. In 1978 a heavily modified Russian Mil Mi-24 'Hind' increased this to 228.9 miles per hour. With Westland under political and commercial pressure, it was decided that an attempt would be made to reclaim the record. Westland re-registered Lynx airframe ZB500 as G-LYNX, and began a programme of extensive modification. More powerful Rolls-Royce Gem 60 gas turbines were fitted, along with a water-methanol injection system, but the biggest performance contribution came from the British Experimental Rotor Programme (BERP). On August 8, 1986, these advanced rotor blades carried G-LYNX pilot Trevor Egginton and his flight engineer Derek Clews to the world record speed of 249.1 miles per hour, which still stands to this day.



The Lynx Mark 3 shares many of the same features as the record-holding G-LYNX, such as BERP blades and Rolls-Royce Gem engines

© Crown Copyright

© Alex Pang



HOW IT
WORKS

MILITARY AIRCRAFT

Strategic bombers

Strategic bombers

Dedicated bombing aircraft act as damage-dealing workhorses, engaging enemy targets 24/7 regardless of weather conditions and the hazardous theatre of war. We take to the skies for a closer look at some of its key players

Deployed to support ground troops in the Libyan civil war, the B-1B Lancer packs a powerful payload



The battlefield has changed. Now, more than ever before, the theatre of war is in flux, rebuilding itself minute-by-minute, breaking down the conventional barriers of geography, geometry and time. Weapons systems are co-evolving along with defense systems at a ferocious rate, fuelled by the continued, perpetual rage of a segregated planet. The relationship between organic and inorganic matter is becoming fused, co-dependent and augmented, in order to generate the versatility demanded when fighting in

the 21st century. Fluidity and reaction speed is now paramount, for if you have the inability to engage immediately on a global scale, the parameters shift and the chance dissipates.

Strategic bombers are positioned at the leading edge of this technological and logistical war, built to offer the range, payload, durability and speed to engage a hostile target quickly and efficiently, no matter their location or levels of defense. Installed with the most cutting-edge technology and weapons systems available these machines excel in

delivering their human operator near-omnipresent power. They include missiles that can transcend the speed of sound three times over, bombs that are guided by invisible, omnipresent satellite links to their targets, and nuclear warheads over ten times the power of that which despoiled Hiroshima. Strategic bombers are also capable of remaining airborne for days, protected by their insane speed and large weapons basket (the range in which they can launch weapons at a target without themselves being engaged).

5 TOP FACTS Bombers

Fortress

1 The B-1 Lancer was originally conceived in the late-Sixties as a supersonic bomber with the range and payload to replace the famous Boeing B-52 Stratofortress.

Father

2 According to Russian government sources, it was a Tu-160 that dropped the 'Father of all bombs'. The government commented: 'all that's alive merely evaporates'.

Iraq

3 The B-1 Lancer was one of the most used aircraft during the Iraq war. One of its most notable missions was an unsuccessful attempt to kill Saddam Hussein.

Swan

4 Russian pilots train to fly the Tu-160 in a Tu-22M aircraft. When they qualify, they can adopt its nickname 'White Swan' (due to its white finish and maneuverability).

Etymology

5 The etymology of 'bomb' comes from the French 'bombe', which comes from the Italian 'bomba', which comes from the Latin 'bombus', which stems from Ancient Greek.

DID YOU KNOW? A single B-1B Lancer costs \$283 million to produce

Tech of the trade

How It Works explains the different types of technology that bombers use to hit their targets

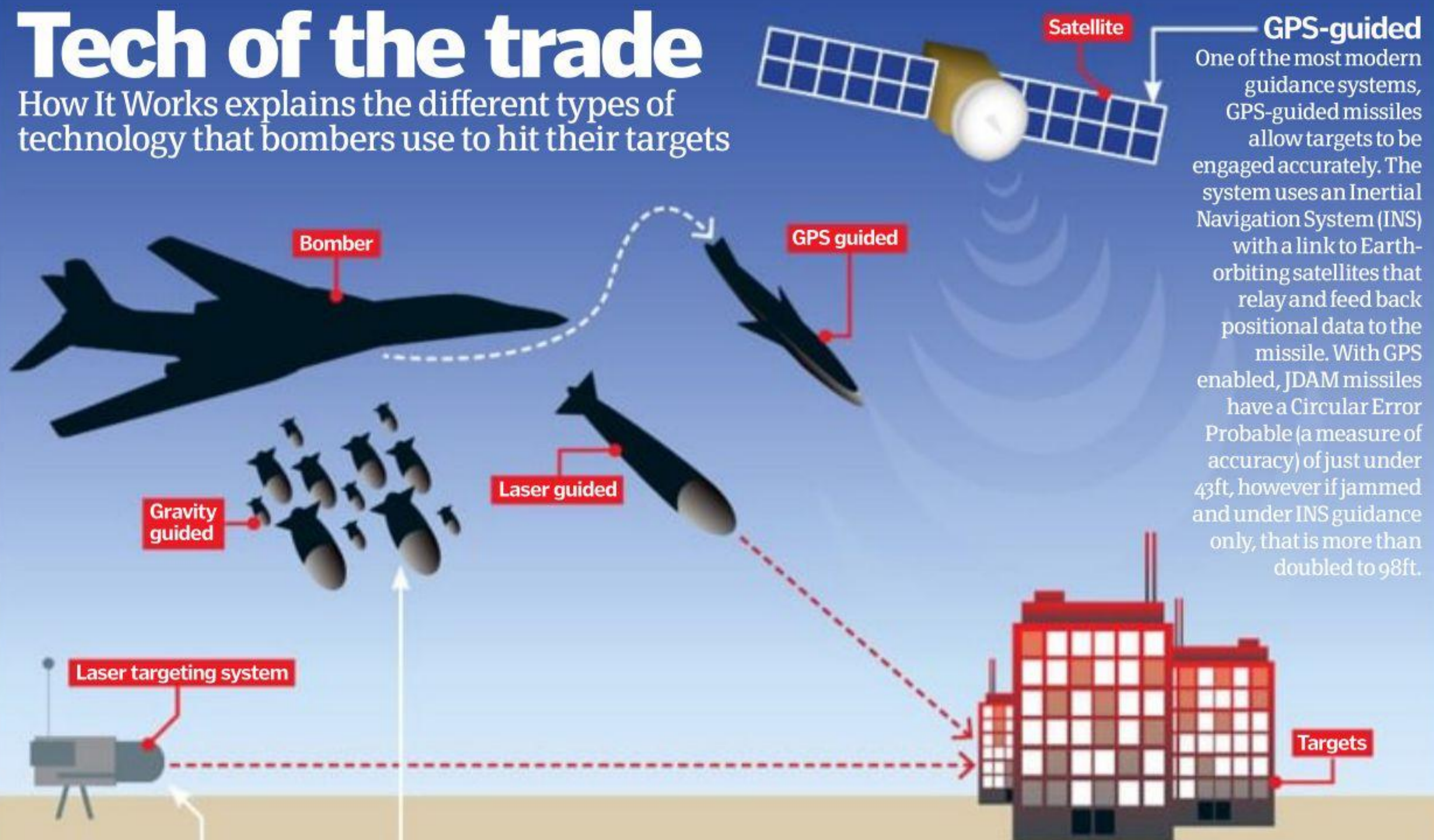

GPS-guided

One of the most modern guidance systems, GPS-guided missiles allow targets to be engaged accurately. The system uses an Inertial Navigation System (INS) with a link to Earth-orbiting satellites that relay and feed back positional data to the missile. With GPS enabled, JDAM missiles have a Circular Error Probable (a measure of accuracy) of just under 43ft, however if jammed and under INS guidance only, that is more than doubled to 98ft.

Laser-guided

Laser-guided systems rely on targets to be 'lit up' with a Laser Target Designator (LTD) system. Usually ground-based, they involve a laser designator being pointed at target. The missile's infrared seeking unit locates the designation and adjusts its trajectory.

Gravity guided

Bombs are dropped free-fall, relying on gravity and aircraft co-ordinates to strike. Due to their relative inaccuracy, gravity-guided bombs tend to be released in clusters to maximize the chance of a successful strike. Dependent on aircraft speed and altitude, these bombs can be fitted with various tails and retarders to speed up/slow down fall time.

The statistics...



B-1B Lancer

- Crew:** 4
- Length:** 146ft
- Wingspan:** 137ft
- Height:** 34ft
- Loaded weight:** 326,000lb
- Powerplant:** 4 x general electric F101-GE-102 augmented turbofans
- Max speed:** Mach 1.25 (830mph)
- Range:** 7,456mi
- Max altitude:** 60,000ft
- Hardpoints:** 9 (6 external, 3 internal)

A B-1B taking off at the Royal International Air Tattoo. Note the firing General Electric F101-GE-102 augmented turbofans



The B-1 is capable of being refuelled during flight for an extended patrol and bombing runs

The two current foremost examples of these bombers are the US B-1B Lancer and the Russian Tupolev Tu-160. These were designed concurrently to be machines that could, on demand, travel long distances quickly, slip under early-warning radar and engage military targets with smart munitions—bombs that could be launched from hundreds or thousands of miles out and guided to their target by internal inertial

navigation units and auxiliary information delivery systems. These strategic bombers, packing gravity, laser and GPS-guided munitions (see 'Tech of the trade' boxout) render anti-aircraft gun placements useless, and avoid surface-to-air missiles by flying at altitudes northwards of 60,000 feet.

The B-1B Lancer is built around a blended wing body configuration, with variable-sweep wings, four turbofan

engines and triangular fin control composite surfaces. Its wings can be varied by the pilot between 15 to 67.5 degrees, with the former being used for takeoff and landing as well as high-altitude cruising, and the latter being used for high subsonic and supersonic flight. Stability is ensured—a problem due to its large size and weight—by triangular fin control canards located by the B-1's nose. These are

WEAPONS OF WAR B-1B Lancer



MK-82

A low-drag, general-purpose, unguided bomb. It is a stock munition for a variety of US aircraft, including the B-1B Lancer, which can carry northwards of 84 units. The MK-82 weighs 500 pounds and measures 87.4 inches long and 10.75 inches in diameter. Each unit has a 192-pound filling of tritonal—80 per cent TNT, 20 per cent aluminium powder—which can be fitted with fin kits, fuses and retarders to suit each mission.



AGM-154

A medium-range launch-and-leave missile, the AGM-154 allows bombing aircraft to engage defended targets from outside the range of conventional anti-air weaponry. The missile, which measures 160 inches long by 13 inches in diameter, is guided by a Global Positioning System of satellites with an internal Inertial Navigation System. This twin system allows for enhanced accuracy and release range.



GBU-39

The GBU-39 is a small-diameter bomb weighing little more than 250 pounds that, dependent on specification, can be guided to a target via a GPS-aided inertial navigation system (as with the AGM-154), or by a thermal seeker with integrated auto target recognition. The thermal seeker works by tracking the electromagnetic radiation of a target with an IR sensor (infrared), before visibly zeroing in on the heat signature once launched.



HOW IT WORKS MILITARY AIRCRAFT

Strategic bombers

"The Tupolev Tu-160 is larger and heavier than the B-1"

controlled by the Lancer's Structural Mode Control System (SMCS), which automatically rotates the canards to counteract turbulence. In addition, to aid the minimisation of its radar cross section (RCS), the B-1 is installed with serpentine air intake ducts and fixed intake ramps. These, while limiting its top speed deflect and shield radar emissions from the highly reflective engine compressor blades. This technology, in partnership with the use of radar-absorbent material in its airframe and skin, grant the B-1 a RCS 1/50th of that of the equally massive B-52 Stratofortress.

The Tupolev Tu-160, in contrast, is larger and heavier than the B-1, however it shares many of the

same features and design choices. First, the aircraft sports a blended wing profile with sweep-enabled wings that can be swept by the pilot between 20 and 65 degrees. It is also powered by four Kuznetsov NK-321 afterburning turbofan engines, the most powerful array fitted to any combat aircraft. These, in partnership with variable air intakes, grant it a B-1 topping max speed of Mach 2.05 (1,380mph), although its radar signature is larger as a result. Due to its larger size, the 160 also has a greater weapons load capacity than the B-1, with twin internal rotary launchers capable of holding and launching 88,185 pounds of munitions. In addition, nuclear and conventional armaments can be carried (see the

'Weapons of war-Tu-160' boxout) dependent on mission parameters. Finally, as with the B-1, the Tu-160 is fitted with a probe and drogue in-flight refuelling system, allowing it to remain airborne for extensive periods.

Both of these aircraft have demonstrated their awesome ability since their introduction to the skies, with numerous sorties undertaken and many notable records broken. In 2011 the USAF deployed a series of B-1s as part of Operation Odyssey Dawn, the international military operation in Libya, to prevent Muammar Gaddafi's forces from bombing rebel forces, striking a multitude of undisclosed military targets across the country.

WEAPONS OF WAR

TU-160



Kh-55

A Soviet/Russian air-launched cruise missile capable of carrying a conventional or nuclear warhead, the Kh-55 is the primary missile system of the Tu-160. It has a range of 1,864 miles and a top speed of Mach 0.78, and thanks to its Inertial Navigation System with a Doppler radar mapping service it has a strike accuracy of within 30 feet. To achieve its range the Kh-55 is powered by an R95-300 turbofan engine, activated along with swept wings once launched. Missiles are stored in a rotary launcher, which rotates missiles like a six-shooter's bullet chamber.



Kh-15

The Kh-15 is a short-to-medium range missile that can be equipped with a nuclear or conventional warhead. Measuring 15 feet in length by 17.9 feet in diameter and with a range of 186 miles, the missile is guided by inertial navigation, active radar or anti-radiation—the latter a system that detects and homes in on an enemy's radio emissions. Central to the Kh-15's design is its post-launch velocity accumulation flight path, climbing to 130,000 feet before diving at a speed of Mach 5 onto its target.

Tu-160

The world's largest variable-sweep aircraft, the Tu-160 is a supersonic strategic missile carrier like no other

Electronics

In terms of electronics, the 160 utilizes a Obzor-K attack radar in a dielectric radome, a Sopka terrain-following radar and electro-optical bombsight.

© Yevgeny Pashmin

A Tu-160 is exhibited to the general public during a Russian airshow



Engines

The four Kuznetsov NK-231 engines of the 160 are ferocious, delivering 55,000lb of thrust each in maximum afterburner configuration.



Munitions

The Tu-160 can carry 88,185lb of munitions, with two rotary launchers capable of stowing conventional or nuclear missiles.

The Tu-160 has the heaviest take-off weight of any combat aircraft



© Sergey Krivchikov-Russian AviaPhoto Team

DID YOU KNOW? On June 10, 2010, two Tu-160s carried out a world-record 23-hour non-stop patrol



President of Russia Vladimir Putin (above) sits in the cockpit of a Tu-160

Cockpit

The Tu-160 is operated by a crew of four, with a pilot, co-pilot, weapons systems operator and defensive systems operator on board each sortie.



The statistics...



© Presidential Press and Information Office

Tu-160

- Crew:** 4
- Length:** 177ft
- Wingspan:** 189ft
- Height:** 43ft
- Loaded weight:** 589,950lb
- Powerplant:** 4 x Samara NK-321 turbofans
- Max speed:** Mach 2.05 (1,380mph)
- Range:** 7,643mi
- Max altitude:** 49,200ft
- Hardpoints:** 4

Wings

The Tu-160 features variable geometry wings, with sweep selectable from 20 to 65 degrees. It also employs a blended wing profile.



A series of Mk-82 bombs explode in quick succession during a test bombing run



A collection of laser-guided bombs connect with Raynham island, Queensland, Australia

The bomber of tomorrow

Inside the jet destined to dominate the skies

Unveiled on December 2, 2022, at Northrop Grumman's (an aerospace and defense company that is one of the largest weapons manufacturers on Earth) facility in California, the B-21 Raider wouldn't look out of place in a sci-fi movie.

Slated to replace both the B-1 and B-2 bombers currently serving in the US Air Force, this futuristic stealth bomber made its maiden

flight on November 10, 2023. With a top speed of Mach 0.8+ (614 miles per hour), a payload of 20,000 pounds and a range of 2,500 miles, this formidable aircraft (which measures 54 feet in length and boasts a wingspan of 132 feet) looks set to rule the skies for many decades to come. In fact, the US Air Force has committed to spending \$203 billion to construct and operate a fleet of 100 B-21s over the next 30 years.



© Boeing



HOW IT
WORKS

MILITARY AIRCRAFT

Attack helicopters



ARMED &
DANGEROUS

ATTACK HELICOPTERS

THE DEADLY GUNSHIPS ELIMINATING THE ENEMY FROM ABOVE



DID YOU KNOW? A Chinook is big enough for two Land Rovers to fit inside it

The AH-64 Apache is one of the most iconic and successful attack helicopters



"Many new gunships were constructed as the Cold War escalated"



The V-280 Valor will attempt to make attack helicopters faster and stronger than ever before

The modern attack helicopter is the complete military machine. Cutting through the air with titanium blades, loaded up with missiles and a cockpit full of advanced technology; they are true terrors of the sky. A tank's worst nightmare, the rise of attack helicopters has revolutionized the battlefield.

The idea of rotary wing military aircraft was first toyed with during the early years of World War II but it wasn't until 1942 that they reached prominence. That year the US War Department proposed a new idea. It was called 'organic Army aviation' and, separate from the Air Corps, it was tasked with developing helicopters. Various new designs, including the revolutionary Sikorsky R-4, were created but it took until the Korean War for helicopters to really take off. Infantry and cargo could now be ferried in and out of battle rapidly and invasion forces could engage the enemy much more effectively from the air. Helicopters were integral to US operations in the rough terrain of Korea and by the time of the Vietnam War, the iconic Bell UH-1 Iroquois was used extensively. The 'Huey' ushered in a new era of air cavalry, as helicopter weaponry became more sophisticated.

Military helicopters were also designed to serve in a purely offensive capacity and the attack helicopter was born. Many new gunships were constructed as the Cold War escalated. These included the American Piasecki H-21 and Bell AH-1 Cobra and the Russian Mil Mi-24. In 1986, the Boeing AH-64 Apache emerged as a template that other armed forces tried to replicate, and helped bring an end to the dominance of tanks on the battlefield. As more breeds of attack helicopter took to the skies, it became clear that these versatile vehicles could assist the military in many ways. This led to the advent of dual and multi-role helicopters.

In recent years, attack helicopters have been equipped with ever more advanced systems that have improved efficiency, aerodynamics and performance. The array of tech on offer is truly astonishing, but there is still room for further progress. Join us as we examine what's on offer for the future of the world's best attack choppers.

TYPES OF MILITARY HELICOPTER

Choppers are an essential part of modern warfare, from reconnaissance to attack



Attack

Commonly known as gunships, attack helicopters come armed with a multitude of rockets, missiles and chain guns. The AH-64 Apache specializes in disabling tanks.



Transport

Supplies and troops can be quickly whisked in and out of war zones. A popular design is the CH-47 Chinook which has a primary role in heavy troop and supply transport.



Multi-role

State-of-the-art navigation and communication systems allow helicopters to assist almost any mission. Their roles range from observation to search and rescue.



Maritime

Maritime helicopters provide invaluable aerial support out at sea. The Sikorsky SH-60 Seahawk takes off from aircraft carriers and frigates and can take down submarines with its MK 54 torpedoes.



Scout

Helicopters like the Aérospatiale Gazelle are used to investigate unknown terrain. They are sent ahead of the front line to inspect what lies in wait for the ground forces.



HOW IT WORKS

MILITARY AIRCRAFT

Attack helicopters

THE TIGER

A heavy-hitting, relentless attack dog, the Airbus Helicopters Tiger has both the armament and performance capabilities to dominate the battlefield. During the Cold War, it was developed in order to respond to any potential attacks on Western Europe by the USSR. The subsequent collapse of the Soviet Union meant it never saw active battle service in that era, but France and Germany continued to work on the helicopter regardless. Today, the Tiger is fully equipped with innovative stealth technology,

The all-action attack gunship that is a key player in modern aerial warfare

highly accurate GPS systems, and electronic countermeasures. It specializes in anti-tank missions but the Tiger's flexibility means that it can handle a variety of roles. The image below is of an HAD combat helicopter but other models include the UHT multi-role fire support, ARH Armed Reconnaissance and HAP combat support. It has been deployed in battle in Afghanistan, Libya and Mali and is currently in service for France, Germany, Spain and Australia.

Mast-mounted sight
Electronics company SAGEM supply the Osiris sight that acts as a forward looking infrared (FLIR) camera and laser rangefinder.

Blades

Made from a fibre-composite construction, the four rotor blades are both light and durable.

Target tracking

The roof-mounted sight features a camera, thermal imaging and a laser tracker, and is stabilized by gyroscopes for a steady aim during flight.

Firing systems

The gunner has a choice of acquiring targets through manual sight or automatic tracking.

A modern attack helicopter

The Tiger boasts some incredible technology that strikes fear into its adversaries

Interface

Both the pilot and aft-seated gunner have a pair of LCD displays that provide sensor data and are used to interact with the Tiger's systems.

Advanced cockpit

The pilot is assisted by an automatic flight control system that lessens the workload during long, strenuous flights and adverse weather conditions.

Cockpit

The Tiger's tandem cockpit allows the pilot and the aft-seat gunner to switch roles if needed, as both have access to the flight controls and weapon systems.

The Tiger's flat and narrow silhouette makes it less vulnerable on the battlefield

"The fuel tanks are self-sealing and explosion suppressive"



DID YOU KNOW? Around 12,000 US helicopters flew in the Vietnam War, totalling 2 million missions and 7.5 million flight hours

AH-64D APACHE LONGBOW

An iconic gunship that's still a capable attack chopper

The AH-64D Apache Longbow gunship is arguably the most famous multi-mission attack helicopter of the modern age. Over its 26 years of service to date it has proven itself both combat-ready and reliable in numerous theatres of conflict.

The AH-64D was upgraded in 2008 to include increased digitisation, a joint tactical radio system, enhanced engines and drive systems, the capability to control UAVs (unmanned aerial vehicles)- which were used extensively in the Iraq and Afghanistan wars-along with improved landing gear. Currently, the Apache AH-64D Longbow is operated by the USA, Egypt, Greece, Israel, Japan, Kuwait, the Netherlands, China, Singapore and the United Arab Emirates, with many other countries operating older Apache variants.

1. T700-GE-701C engines

The turboshaft engines allow the AH-64D Longbow to reach a cruise speed of 176mph.

2. Automatic cannon

The 30mm automatic cannon is capable of firing large, highly incendiary rounds.

3. Hellfire missiles

These laser-guided missiles are effective at taking down enemy armour and structures.

4. Explosive rockets

Fast firing 70mm rockets allow the Apache to support ground troops in any assault on enemy soldiers, strongholds or vehicles.

5. Cockpit

With room for two, the Apache's cockpit allows excellent battlefield visibility with wide viewing angles.

6. Composite rotor blades

A composite four-blade main rotor allows for increased payload, climb rate and cruise speed over earlier variants.

7. Fuselage

Designed for maneuverability and stealth, the fuselage is painted in camouflaged colours.

8. Radar dome

This system enables target detection from behind obstacles.

An AH-64D fires its flares as a countermeasure against infrared missile seekers

Power

The Tiger is powered by two 960kW turboshaft engines. The fuel tanks are self-sealing and explosion suppressive when exposed to enemy fire or in the event of a crash.

Fuselage

Kevlar, carbon laminates and Nomex make up 80 per cent of the airframe, and radar reflective surfaces are kept to a minimum.

Mistral missiles

With a 6.6lb warhead and a 3.7mi range, the Tiger can cause significant air-to-air damage over long distances.

Weaponry

The Tiger can be fitted with different combinations of weapons depending on the variant, suitable for both air-to-ground and air-to-air combat.





HOW IT WORKS

MILITARY AIRCRAFT

Attack helicopters



The Bluecopter

Introducing Airbus' eco-efficient demonstrator—a game-changer that could make choppers more stealthy

Reduced emissions

CO₂ emissions and fuel consumption are decreased by up to 40 and 10 per cent respectively.

Blue Edge technology

The five Bluecopter blades decrease noise pollution without affecting performance.

Rudder

The T-tail stabilizes the vehicle, decreasing the tendency for the nose to rise up.

Blue Pulse tech

Active flap rotor control reduces the interference of the blades with each other, reducing noise levels.

Tail rotor

The Fenestron is a tail rotor housed in an insulated duct to reduce drag and noise.

Eco-mode

One of the Bluecopter's engines can be temporarily shut down to decrease emissions.

Aft-body concept

The design of the back of the helicopter helps make it more aerodynamic.

Skids

A specially made fairing on the skids lowers the Bluecopter's drag.



The Bluecopter has allowed Airbus to test innovative, eco-friendly technologies

STEALTH HELICOPTERS

How tech can help make choppers a whole lot quieter

One of a military helicopter's biggest strengths is its maneuverability. Being able to take off and land in difficult terrain, move in any direction and hover makes gunships incredibly useful in battle. However, this advantage comes at a price and the sound of the rotor blades spinning almost negates any chance of a stealthy approach. Helicopter blades are noisy because of blade-vortex interaction (BVI). Each blade rotates at such a speed that high amounts of turbulence are caused. Huge amounts of air flow around the blades as they turn and a concentrated vortex (a whirling mass of air similar to a whirlwind) is formed. As each following blade cuts through this vortex, acoustic energy and vibrations are created, resulting in the classic chopper sound. It

has been a long-standing issue but now various technologies are being implemented in an attempt to reduce it.

Airbus' Bluecopter has a new style of rotor blade that utilizes Blue Edge technology. The innovative double-swept design reduces noise by four decibels by reducing the surface area of the blade that impacts on the vortex. This is complemented by Blue Pulse technology, which incorporates three flap modules into every blade. Directed by a flap rotor control that uses tiny electric motors powered by crystals, they move at up to 40 times a second, lessening the BVI as less pressure is created. This decreases the level of noise generated and gives the pilot a smoother ride with a huge reduction in cabin vibrations.

Another method the Bluecopter is using to make it both greener and stealthier is a Fenestron. This encases the tail rotor and allows the mechanism to have more blades, which adds more thrust, while reducing drag and vibration. On the Bluecopter, stealth technology is used in conjunction with aerodynamic landing skid fairings and a T-tail stabilizing rudder to increase efficiency and decrease emissions.

"The innovative double swept design reduces noise by up to four decibels"

Operation Neptune Spear



On May 1, 2011, US President Barack Obama declared to the world that Osama bin Laden had been killed. The operation that disposed of the founder of Al-Qaeda was codenamed

Operation Neptune Spear and was undertaken in two Black Hawk helicopters supported by two MH-47 Chinooks. During the mission, one of the Black Hawks ran into difficulty and had to make a hard landing. It was reported that before leaving, the SEALs made efforts to destroy the downed chopper, leading aviation analysts to believe they were equipped with secret stealth technology. US authorities have remained tight-lipped on the matter, but photos of the surviving wreckage appeared to show modifications to the tail section to suppress noise and avoid radar.



The UH-60 Black Hawk has become the US Army's premier multi-role helicopter

TYPES OF MILITARY HELICOPTER MISSIONS

Powerful, agile and resilient, the Tiger is the chopper of choice in many situations



Ground fire support

Infantry and armoured divisions on the ground can rely on the Tiger to provide backup. The 30mm gun is incredibly accurate and can fire at a maximum distance of 6,562ft.



Amphibious operations

The Tiger HAD is also a worthy adversary at sea. It was designed to be able to land on aircraft and its low maintenance requirements mean it can stay out at sea for long periods.



Escort

Operations in Afghanistan, Libya and Mali allowed the Tiger to display its prowess as an escort chopper. It can easily eliminate threats and guide others to safety.



Armed reconnaissance

Day and night identification sensors make the Tiger a highly competent reconnaissance unit that can weave through tough terrain and also engage the enemy if it needs to.



Aerial combat

The twin attack power of a 30mm turreted gun and Mistral missiles are more than a match for any other helicopter. Also on board are 32 chaff and flare cartridges.



Anti-tank warfare

The range of powerful anti-tank missiles at the Tiger's disposal make it the ideal gunship. It can take out tanks from a safe distance, firing from up to 26,247ft away.

Ask the expert

We spoke to Marius Bebesel, programme manager at Airbus to explain more about the Bluecopter

What sort of helicopter is the Bluecopter?

Based on an H135, the Bluecopter technology demonstrator is a light, twin-engine helicopter. It is a flying technology test bed, on which Airbus Helicopters is able to trial next-generation eco-friendly technologies that can be applied across Airbus Helicopters' product line. The Bluecopter is a unique, one-of-a-kind, test aircraft.

How environmentally friendly and energy efficient is it?

The Bluecopter allowed Airbus Helicopters to test performance and fuel management

technologies (including an 'eco-mode', which shuts down one of the two engines during standard cruise) leading to a ten per cent reduction in fuel consumption, helping to achieve a 40 per cent CO₂ emissions reduction.

The demonstrator features several design measures to reduce the aerodynamic drag of the helicopter. This includes fairings for the main rotor hub and the landing skids, and a newly developed low drag aft-body concept.

The eco-friendly approach is extended even to the attractive paint scheme of the helicopter, which makes use of the latest water-based paint technologies.



Do you have plans for any electric helicopters?

Airbus Helicopters is researching lower emissions technology with its compound helicopter LifeRCraft and the High Compression Engine (using an advanced diesel engine instead of a turbine for light helicopters).

Airbus Group has teamed up with Siemens to research electric flight. It is thought that by 2030 passenger aircraft below 100 seats could be propelled by hybrid propulsion systems.



V-280 Valor

The innovative Bell and Lockheed Martin design that boasts unrivalled speed, range and payload capabilities

VTOL technology

The advanced tilt-rotor technology will allow for vertical lift-offs from almost any terrain.

Sensor technology

Enhanced situational awareness systems ensure bombing during missions is incredibly precise.

Tilt-rotor

The counter-rotating dual propellers enable great maneuverability.

Capacity

The large armoured fuselage can fit 14 troops and four crew members.

Speed and endurance

The top speed will be over 310mph, with a combat range of nearly 930mi.

Rotor downwash

Decreased downwash from the rotor blades makes rope hoist operations easier and safer.

The innovative technologies used on the Raider allow it to reach much higher speeds than standard choppers



MILITARY HELICOPTERS: THE NEXT GENERATION

What does the future have in store for a new class of supercopter?

While the Boeing AH-64 Apache and the Sikorsky UH-60 Black Hawk are still capable gunships, even more advanced updates are on the horizon. In 2019, Boeing and Sikorsky joined forces to develop the SB>1 Defiant, going head to head with Bell and Lockheed's rival project, the V-280 Valor, in a bid to win the right to replace the US Air Force's fleet of UH-60 Black Hawk helicopters, the aim of the Future Long-Range Assault Aircraft initiative, which is itself part of the wider Future Vertical Lift (FVL) project.

This program will see five different types of helicopter developed to replace the UH-60, AH-64 Apache, CH-47 Chinook and OH-58 Kiowa

models. As well as having first-class combat capabilities, the new helicopters will embrace semi-autonomous technology and be flexible enough to serve in urban security, disaster relief and medical evacuation. Each of the aircraft will use a new active system that will advise the crew on when components in the cockpit need

"The new helicopters will embrace semi-autonomous technology"

to be replaced, while also giving as much assistance as possible to the pilot. Compatibility with other vehicles will be at the forefront of the new choppers' design. They will be capable of landing on ships and being stored on cargo planes. These ultra-advanced helicopters are set to be in production by 2030 and will serve the US Army, Navy, Air Force and Marine Corps.

On December 5, 2022, the V-280 Valor emerged victorious in its battle with the SB>1, being selected by the US military to replace the UH-60.

As well as attack helicopters, the classic Chinook design will also be getting an overhaul. The Block II Chinook programme will see

DID YOU KNOW? It costs approximately \$30 million to build a single V-280 Valor

SB>1 Defiant

Sikorsky and Boeing's joint venture may not have been selected, but that doesn't detract from its awesome arsenal

Coaxial rotors

The double counter-rotating rotors were immensely powerful yet agile enough to land on aircraft carriers.

Full of fuel

The large fuel tanks were designed to hold enough to fuel a powerful future engine.

Pusher propeller

The pusher propeller allowed for top speeds of over 280mph even in adverse weather conditions.

Autonomous assistance

Fly-by-wire technology could guide the chopper to safety if the pilot was injured or incapacitated.

Advanced cockpit

The pilot was to be assisted by cognitive decision-aiding technology that prioritized the flow of navigational information.

Spacious fuselage

The chopper weighed over 13 tons and could transport 12 soldiers and a crew of four.

Defense mechanism

A high-tech laser jammer was installed to divert the path of any missiles targeting the SB>1 Defiant.

© Boeing/Sikorsky

Boeing's iconic twin rotor vehicles undergo a modernisation project. They will still utilize the same basic design but will be kitted out with an assortment of modern technology. All the projects are a fascinating glimpse into the future and will build on the already cutting-edge technology used in today's helicopters. While drones continue their vital role on the front line of aerial combat, the attack helicopter will once again dominate the skies with more advanced engineering and weaponry than ever before.



The Raider's cockpit can fit two pilots and the cabin will have space for six soldiers

S-97 Raider



Sikorsky is currently developing a new generation of helicopter. Utilizing innovative technology, the S-97 Raider has not one but two coaxial counter-rotating rotors. These rotors are mounted on the

same shaft but rotate in opposite directions. This advanced rotor-wing technology will be accompanied by a push propeller at the rear and will enable the vehicle to reach altitudes of 9,843 feet even in the most challenging climates, traveling at twice the speed of the fastest helicopters currently in the air. As well as its superior performance, the Raider is designed to have a reduced turning radius and lower sound emissions than current helicopters. Its likely role within the military will be as a light tactical vehicle but it still packs a punch and comes equipped with Hellfire missiles. The Raider will be equally adept at armed reconnaissance and search and rescue missions and comes complete with retractable landing gear, vibration control and thermal management systems for this purpose.

The Raider conducted its maiden flight in 2015 and is currently still under development





Commercial



74

- 68 Commercial drones**
How drones and unmanned aerial vehicles (UAVs) will change your life
- 74 How to build a plane**
How many people and hours does it take to build a passenger jet?
- 78 The Lineage 100 jet**
Fly in the most luxurious hotel in the sky for only a few million dollars
- 80 Largest passenger jet**
Developing the largest and most expensive passenger plane in the world

- 82 Solar-powered aircraft**
Take a close look at the flying machines that are fuelled only by the Sun
- 84 On board a cargo plane**
Pinpointing what an aircraft needs to get the job of carrying cargo done
- 86 Boeing 787 Dreamliner**
The new commercial jetliner that showcases the future of flying
- 90 Hypersonic flight**
Take a look inside the planes that will smash the supersonic speed records

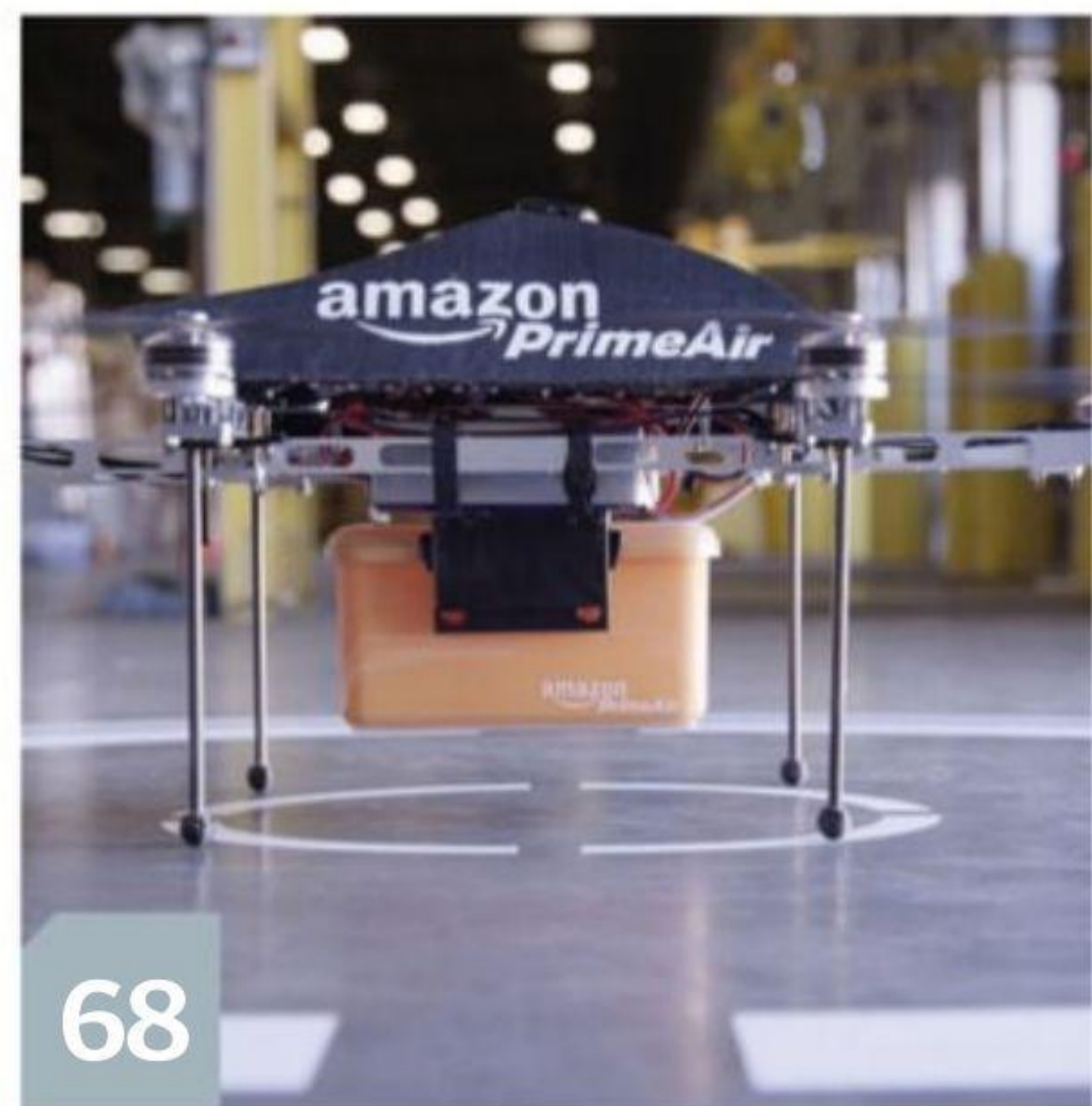

68

80



98



86

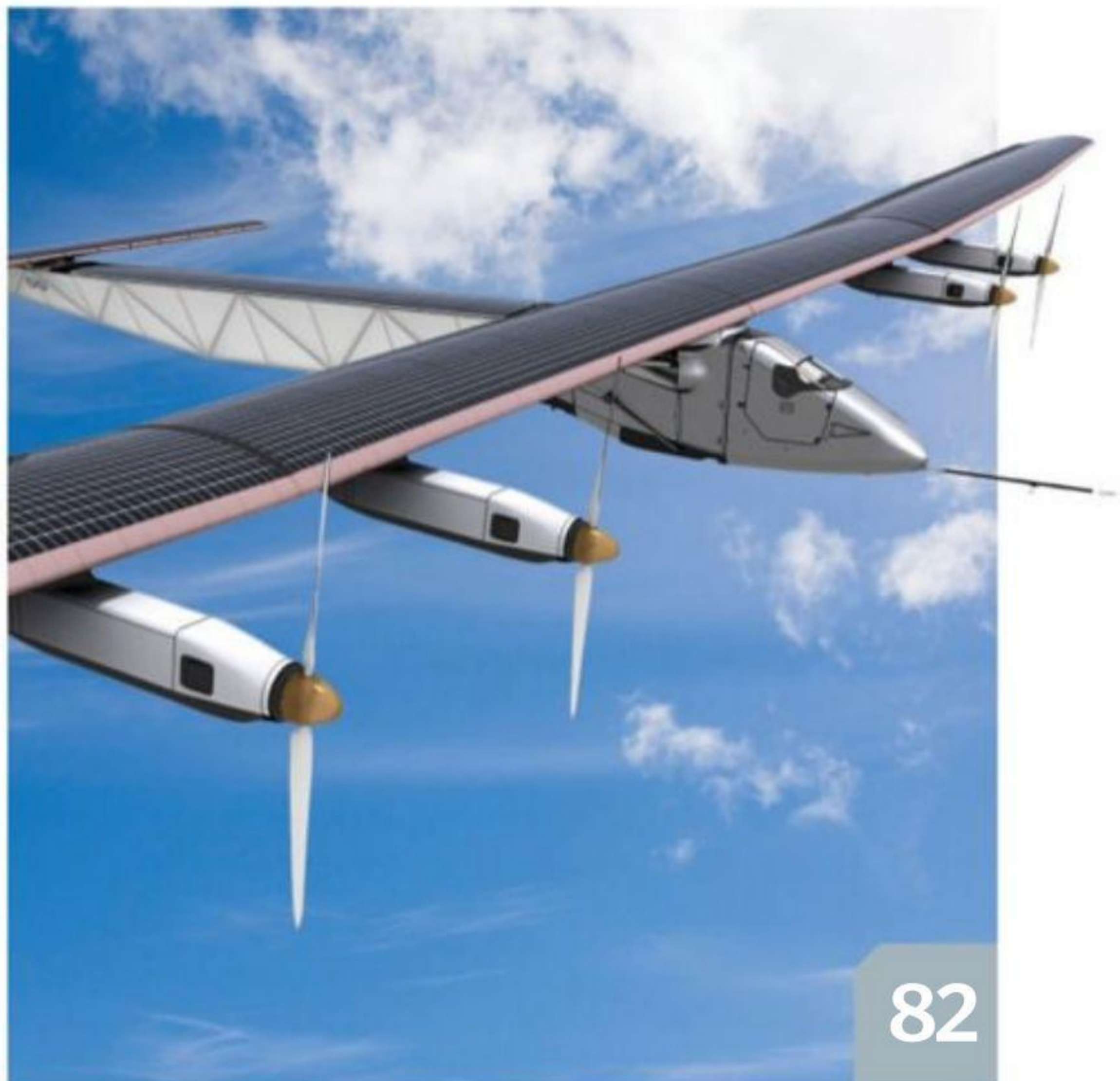

82



HOW IT WORKS

COMMERCIAL AIRCRAFT

Drones



The Parrot 2.0's processing unit is a 1GHz, 32-bit A8 processor.

This drone can stream 720p video footage straight to your phone.

How unmanned flight will change your life

The lightweight expanded polypropylene body helps the UX5 weigh just 5.5lb.

The operator can be 3mi away from the UX5 and still control it.

The Draganflyer X6 can carry one of several different imaging devices, including a thermal imaging camera.

The Matternet drone can carry up to 4lb of medical supplies between ground stations.

If it is flown out of the remote control's range, this drone automatically returns home.

The Phantom 2 Vision+ is capable of shooting 1080p HD video at 30fps.

5 TOP FACTS

Drone tech

Also known as

1 The name drone refers to any aircraft without a pilot on board. They are also known as unmanned aerial vehicles (UAVs), remote piloted aircraft (RPA) or unpiloted air systems (UAS).

Future swarms

2 There are over 4,000 different UAVs in circulation on the global market and the FAA estimates that as many as 7,500 small commercial drones could be operational in US airspace by 2020.

Friendly drones

3 In Britain, manufacturers have suggested painting drones in bright colours as a way to make them appear friendlier and less reminiscent of warzones.

The first drone

4 The first powered UAV was the "Aerial Target" invented by Archibald Montgomery Low in 1917. It was launched using compressed air from the back of a lorry.

Control methods

5 Drones can be controlled in one of two ways; either autonomously by an on-board computer, or remotely by a pilot on the ground.

DID YOU KNOW? The number of organizations allowed to use drones in the UK went up 80 per cent from start to end of 2014



Drones are being used in air forces around the world, but the future is looking much more varied for the remote controlled aircraft. There is a fast-growing industry of autonomous flight that can both help and entertain the world, from rescuing people at sea to recording awe-inspiring aerial videos.

Disaster relief, for example, is a major area where drones can make an incredible difference. They can fly over the scene of an earthquake, nuclear meltdown or bomb site and capture high-resolution pictures or video to help the team on the ground organize a rescue or clean-up mission. Drones such as the Trimble UX5 could be of enormous benefit as the 2.4-gigahertz modems in the craft and the tablet can communicate over a distance of 3.1 miles, enabling mapping to take place with the pilot nowhere near potentially dangerous rubble and aftershocks.

When the Fukushima nuclear power plant malfunctioned in March 2011, clean-ups and analysis of the radiation was limited due to the health risks posed to helicopter pilots.

Drones such as the Advanced Airborne Radiation Monitoring (AARM) system designed

by Dr James MacFarlane at the University of Bristol could put an end to that. This particular craft is a hexacopter with a gamma spectrometer attached, which measures the amount of radiation being emitted from a chosen site. This can be done without a human anywhere near the area, so information can be received much more quickly and safely.

One of the most exciting commercial applications of drones is aerial photography and videoing. In the past, shooting any kind of media from the air required the hire of cranes or helicopters. Now, however, drone-mounted cameras can be bought for as little as \$80, enabling amateur photographers and film-makers to capture amazing high-definition footage for a fraction of the cost.

Although drones might seem the futuristic domain of governments, the military and serious enthusiasts, there are a number of extremely practical day-to-day applications they can be used for. Amazon and DHL are both



Drones offer a whole new perspective on video recording and photography

deep into the testing stage of delivery drones. You may remember the end of 2013, when Amazon claimed drones would be delivering small packages within five years. Currently the use of drones

for commercial purposes is banned in the United States, but

Amazon has petitioned the Federal Aviation Authority (FAA) to relax their rules to allow small drones to carry payloads of five pounds to customers. This weight, they say, makes up 86 per cent of their deliveries and would take big, bulky and dangerous delivery vehicles off the road. DHL has already flown test missions from the German mainland to the island of Juist, off its northern coastline.

Commercial drones are a far cry from their headline-grabbing military cousins, but they are every bit as exciting, packed with fascinating technology and the ability to perform tasks that makes our lives, and the world, a little bit safer and a whole lot more fun.



The AARM won its inventor, Dr James MacFarlane, the 2014 ERA Foundation Entrepreneurs Award

© Thinkstock



HOW IT WORKS

COMMERCIAL AIRCRAFT

Drones

LIFE-SAVERS

Discover the innovative drones designed to rescue those in need

The agility and efficiency of these incredible machines often means they are better equipped than humans or other vehicles for humanitarian tasks. From transporting aid to spotting someone in need, there is a variety of potentially life-saving drone aircraft projects that are currently in development.

One such initiative is the LifeLine Response app, a personal panic button that will summon a drone if you are in distress. If you are concerned about your safety, you can simply load the app and keep your thumb pressed on the screen or set a timer. If you get into trouble, you can release your thumb or fail to deactivate the timer, and the police will be called and a drone deployed to your location using GPS.

The idea is that the drone, which can travel at 60 miles per hour, will be able to scare off an attacker by sounding an alarm, follow them if they flee the scene, and collect information from the area before the police arrive. It is hoped the system could be used in cities across the world, with dozens of drones stationed at each law-enforcement headquarters waiting to spring into action.

Another concept, developed by Dutch engineering student Alec Momont, involves 'ambulance drones' quickly delivering defibrillators to heart-attack victims. The drone would be able to transport the equipment within minutes, and then the operator can use two-way video supported

communication to instruct a nearby helper to use it.

While some life-saving drones are still a work in progress, others are already being put to work. For example, Draganflyer drones are being used to provide a unique high-resolution view of disaster zones and crash sites to help teams on the ground locate victims, organize rescue missions and document the scene.

Draganflyer makes several different models of drone suited to both hobbyist and professional applications. These come with a choice of camera, including a GoPro and thermal-imaging camera, and are flown using a handheld controller, but you will need some training in order to operate one.

Draganflyer X6
The main components of a life-saving drone

LED lights
High-intensity LED lights aid navigation in the dark and can be remotely controlled by the operator.

Efficient propellers
The carbon fibre propellers help the drone climb to a maximum altitude of 8,000ft at 6.5ft/s.

Sensors
11 different on-board sensors constantly monitor the altitude of the aircraft and send data to the controller.

Portability
The carbon-fibre airframe can be folded down to just 6.25in wide when not in use.

Quiet motors
Each boom contains two quiet yet powerful brushless motors that control the propellers and create just 72db of sound.

Battery life
The lithium polymer battery can keep the drone in the air for approximately 20-25 minutes between charges.

Payload attachment
The quick-release payload system makes it easy to swap over cameras or other equipment in a hurry.

12oz
Max payload weight

Draganflyer story

We spoke to Kevin Lauscher from Draganflyer about the incredible innovations of the X6



What is the main purpose of the X6?

The Draganflyer X6 was developed as a safe and easy-to-use platform to carry an

aerial imaging system that provided clear high-resolution images. At the time of development, systems that could carry a high-resolution camera were generally large, dangerous and difficult to control.

What sets it apart from other drones in existence?

It has a unique design with six rotors in the Y-style configuration, as well as its ability to fly even if it is missing one of the rotors. When it was first released, the concept of using sUAS (Small Unmanned Aircraft Systems) for civilian purposes was practically unheard of, so the attention it received made it stand out from other models.

What are your hopes for the X6 in the future?

The Draganflyer X6 was our first industrial system and was responsible for setting a lot of firsts for the industry. Since then we have developed other improved systems based on our experience with the X6. Our hopes are to work some technology upgrades into its design and for it to again become a front-runner in the sUAS world.



The Draganflyer X6 can carry cameras weighing 11.8oz or less, including a GoPro

LIFEGUARD DRONE

Getting help to those in trouble out at sea is especially difficult and slow, particularly in adverse weather conditions. Iranian company RTS Lab hopes drones can solve this, as it is currently developing a new lifeguard robot called Pars. After hearing about the huge number of people that drown in the Caspian Sea each year, RTS Lab decided to create a multirotor drone that could help save human lives. As well as being able to fly

above the water and be guided by GPS, Pars can also carry and drop life preservers to where they are needed. Although it is not able to pull people to safety, it can provide initial aid before the lifeguard arrives and monitor the situation by recording photos and video. A prototype has already been tested and was able to reach a target 246 feet out to sea in just 22 seconds, while a human lifeguard took over a minute to get to the same target.

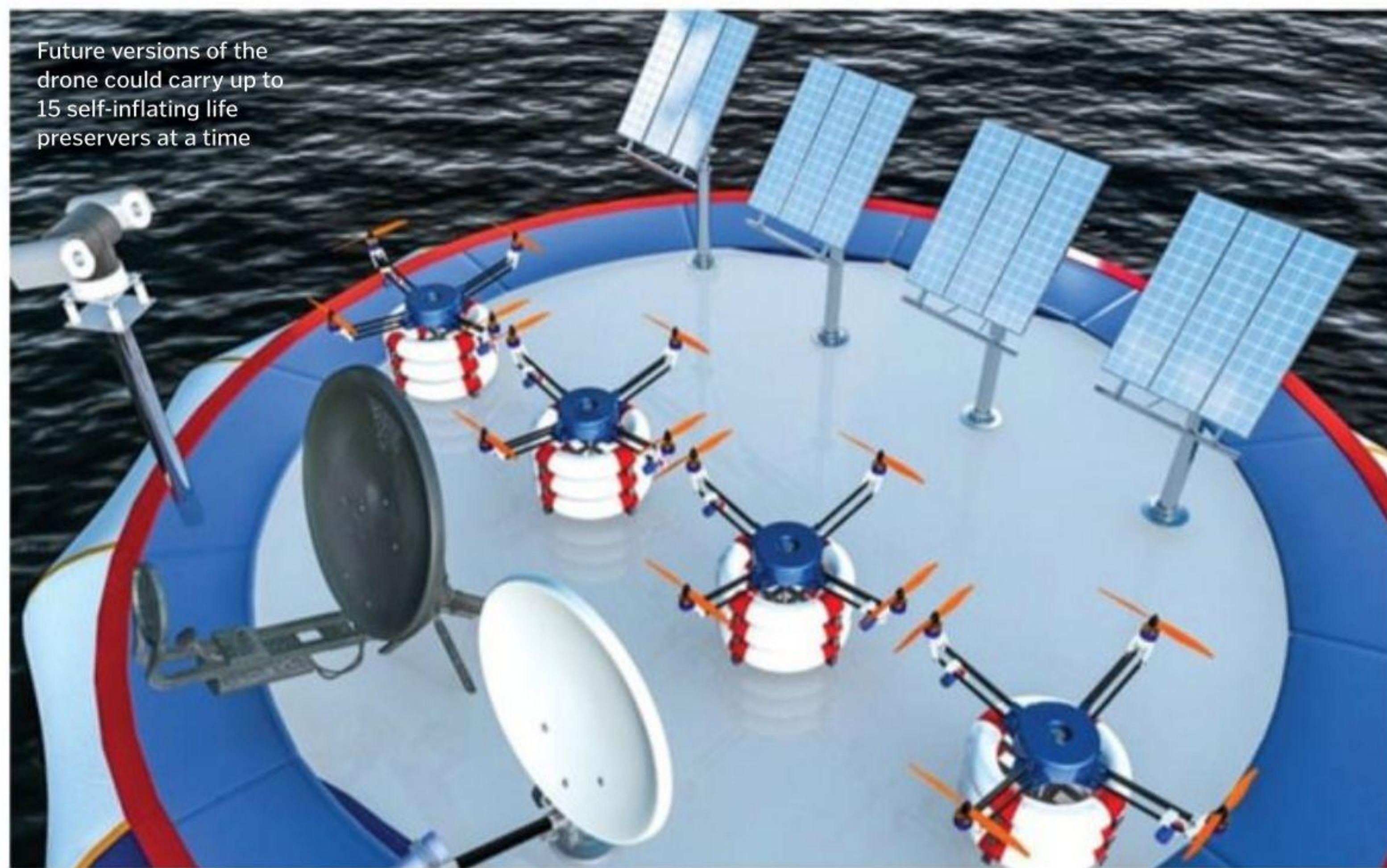

Future versions of the drone could carry up to 15 self-inflating life preservers at a time

DELIVERING AID

In many developing countries, rural roads become inaccessible during the rainy season, making it very difficult to transport much-needed medicine to those in need. Matternet—a network for transporting matter—aims to provide the solution. The plan involves autonomous drones, carrying up to 4.4 pounds of medical supplies, flying between several ground stations. These stations would allow the drones to collect or drop off their payload as well as swap batteries so they can keep flying for longer. The drones will use GPS and other sensors to navigate and an operating system would make sure they avoid adverse weather conditions and do not collide.

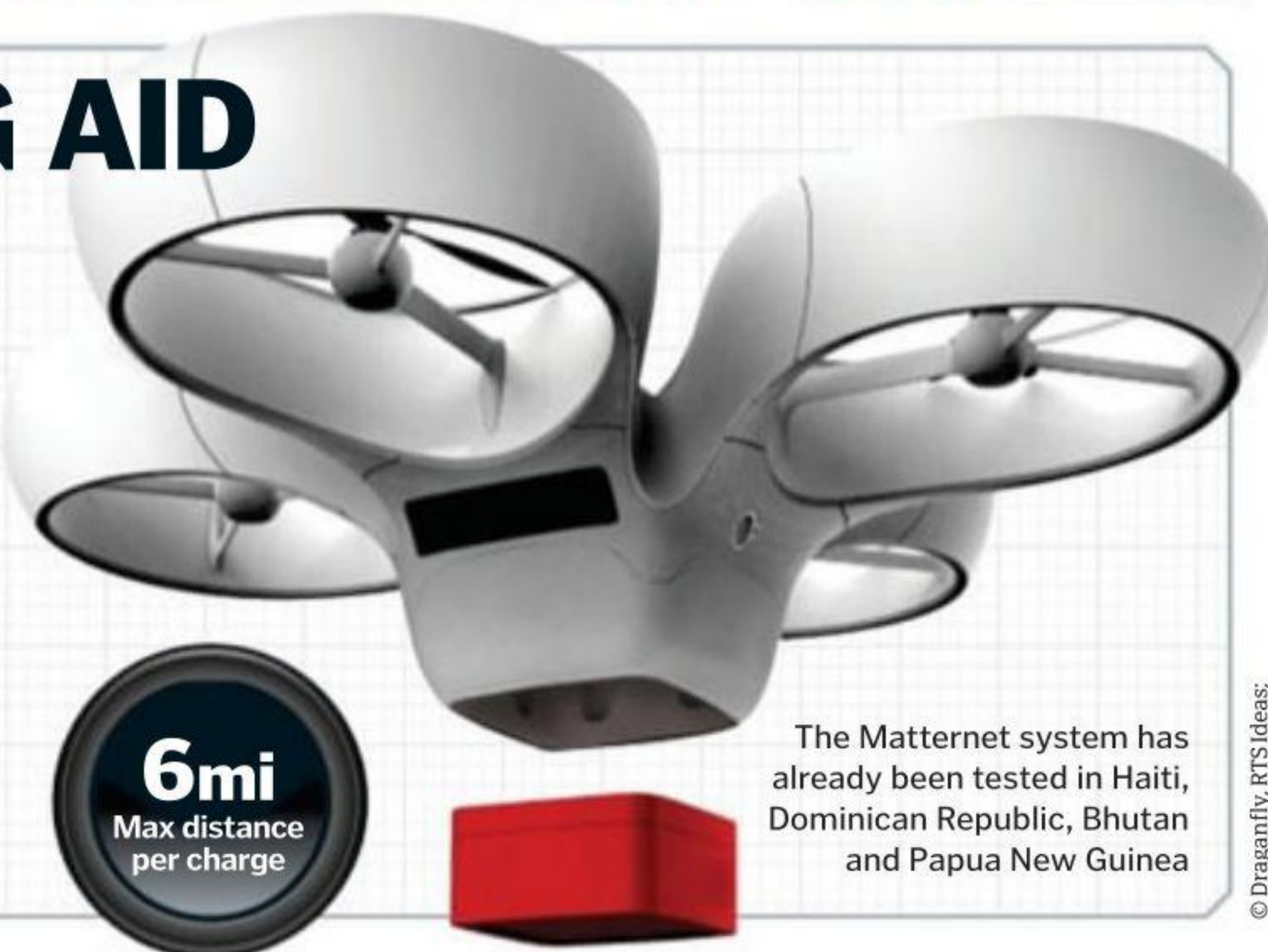

The Matternet system has already been tested in Haiti, Dominican Republic, Bhutan and Papua New Guinea



HOW IT WORKS

COMMERCIAL AIRCRAFT

Drones



The Parrot AR.Drone 2.0 is controlled via an app on your Android or Apple device

COMMERCIAL USE

The drones offering film-makers a whole new perspective

Drones such as the Parrot AR and the DJI Phantom 2 Vision+ have added a thrilling new dimension to personal photography and filmmaking. These clever gadgets are becoming more and more affordable for amateurs looking to capture Hollywood-style footage from unique angles. A Parrot AR. Drone, for example, will only set you back around \$300 and has a built-in camera that can shoot 720-pixel high-definition video.

It generates its own Wi-Fi hotspot so you can control it from up to 165 feet away via an app on your smartphone or tablet. The app also shows a live stream of the video being captured and lets you change its direction by simple tilting your device. It can even perform impressive acrobatic flips and tricks in mid-air, and you can program automatic movements to compose your film like a professional director.

If you do happen to crash the drone while filming a daring action sequence, then you can have a go at repairing it yourself as all of the parts and instructions are available online. Due to the

relatively recent advancement of commercial drone technology, many countries are still developing laws regarding their use in public spaces. In the United States, the Federal Aviation Administration currently limits drones to be flown below 400 feet, away from airports and air traffic, and within sight of the operator.

Using drones in a professional capacity requires a certificate of approval from the FAA, but it has recently granted six movie and television production companies permission to use drones on their sets. Some big blockbusters, such as *Skyfall* and the *Harry Potter* movies, have already been shot using unmanned drones for aerial footage, but filming took place in countries where this was allowed.

We are already seeing more and more drone-shot sequences on the big screen. Not only is this great news for us cinemagoers, as we will be treated to more creative camera angles, but it will also save the production companies a lot of money on helicopter and crane bills as they try to get above the action while filming.

AR.Drone teardown

The incredible Parrot AR. Drone 2.0, bit by bit

Motors

When accelerating, the motors that turn the propellers rotate at 41,400rpm, dropping to 28,000rpm when hovering in place.



Battery

The drone is powered by a 1,000mAh 11.1V lithium polymer battery. It only lasts 12 minutes, taking 90 to charge.



Propellers

The propellers won a design competition run by the French Army. They can spin either clockwise or anti-clockwise depending on their position.

The solar-powered Zephyr drone developed by UK firm QinetiQ flew for 14 days and 22 minutes in 2010, breaking the world record for the longest drone flight.

DID YOU KNOW? TV coverage of skiers and snowboarders at the 2014 Winter Olympics in Sochi was shot by unmanned drones



Hull
The hull is attached to the body by a pair of magnets. This protects the electronics.

Central cross
Made from rigid yet lightweight carbon fibre, the central cross contains wires that control and provide power to the four motors.

Camera
The HD camera shoots 30fps at 720p, streaming it directly to your cell phone.

Ultrasonic altimeter
The ultrasonic altimeter judges how high it is by the time it takes ultrasound waves to return from the ground.

Gyroscope
The Invensense IDG 500 gyroscope is an advanced sensor that separates the X and Y-axes to quickly determine its position.

BEST FOR... VIDEO STREAMING



DJI Phantom 2 Vision+
Price: \$625 • Get it from: www.dji.com

BEST FOR... EVERYDAY FUN



Parrot MiniDrone Rolling Spider
Price: \$100 • Get it from: amazon.co.uk

BEST FOR... BEGINNERS



Walkera QR Ladybird V2
Price: \$79 • Get it from: walkera.com

BEST FOR... STUNTS



Blade 350 QX V2
Price: \$575 • Get it from: quadcopters.co.uk

BEST FOR... AFFORDABILITY



Hubsan X4 H107
Price: \$70 • Get it from: amazon.co.uk



HOW IT
WORKS

COMMERCIAL AIRCRAFT

How to build a plane

Wind tunnels are used to test the aerodynamics of aircraft models

HOW TO BUILD A PLANE

From concept to check-in, discover how passenger jets roll off the production line and take to the sky

STEP 1: Design and testing

Before building can begin, the aircraft must first be designed in great detail. Thousands of engineers across the world often work together to design one plane, and it can take several years to get it right.

When designing an aircraft, there are four main areas to consider. First it must be aerodynamic, so that air flows around it with as little resistance as possible. To test this, engineers create computer simulations of the plane and examine how airflow and pressure will affect the body and wings when it is in flight. They then build a scale model of the aircraft and place it in a wind tunnel, where air is

blown towards it at varying speeds in order to test its flight performance.

Next they must design the engines, making sure they are powerful enough to keep the aircraft in the air, fuel efficient to minimize running costs and pollution, and not too noisy. The way the plane handles in the air must also be considered, and so flight simulators are used to ensure it is easy and safe for the pilot to fly.

Finally, engineers determine what material to build the aircraft from, considering strength, weight, durability and cost, and how exactly it will be built.

Computer simulations help engineers see how air flows around an aircraft

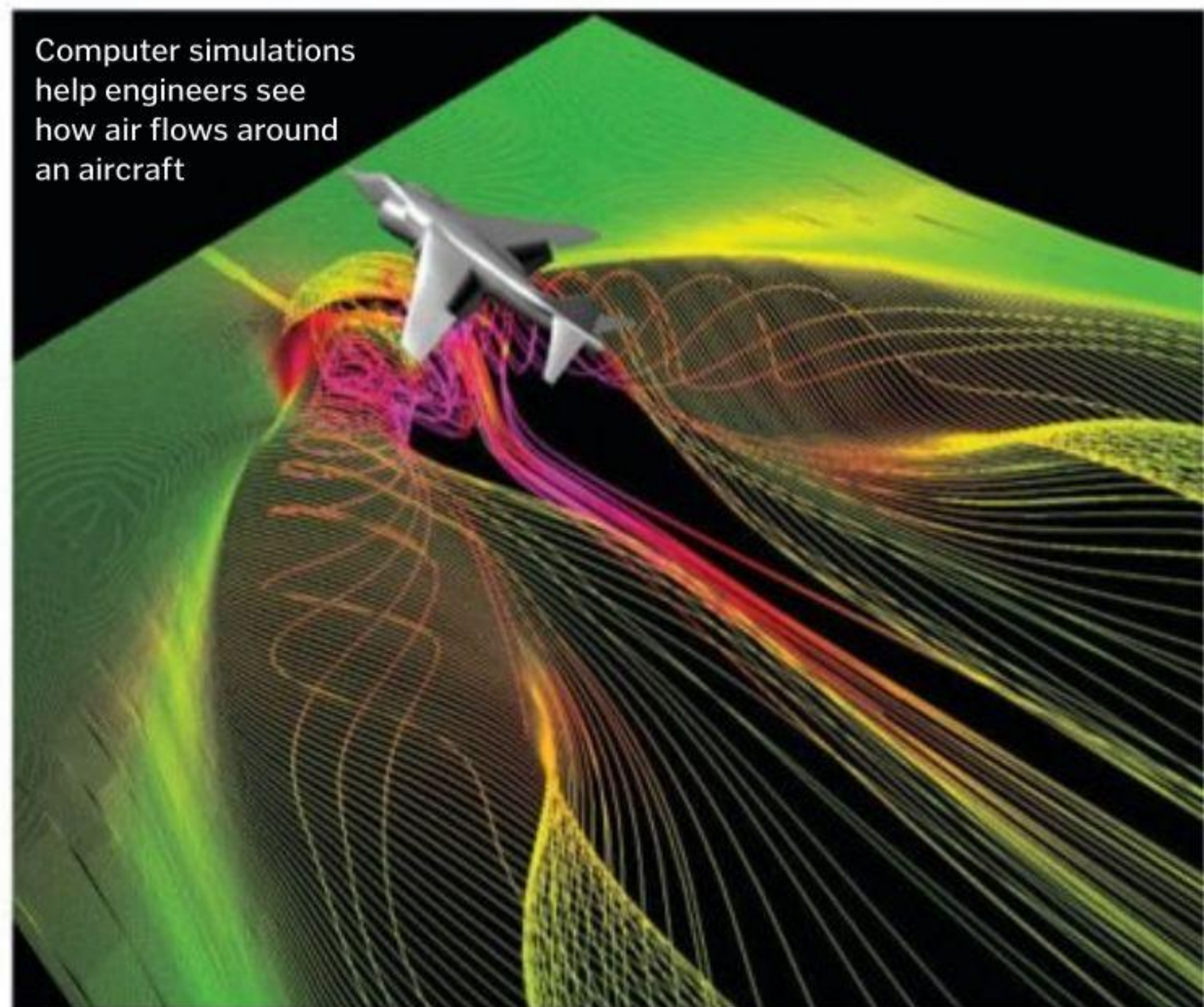

DID YOU KNOW? In 2018, Airbus aims to be building 13 A350 aircraft every month, completing one every two working days

STEP 2: Making the parts

A plane is made up of millions of different parts, from the enormous fuselage shell to the tiny rivets that hold it together. Many are made by the aircraft manufacturer itself, while others, including the engines and landing gear, are produced by external contractors. A huge number of different skills are required to build an aircraft, from mechanics and electronics, to

plumbing and painting, so it takes teams from all over the world to make the finished product. Coordinating the production of a plane is a task in itself, as everything has to be made to a tight schedule and then transported to where it is needed for assembly. Plus, each part has to undergo rigorous testing to ensure it functions properly and is safe to use in the final aircraft.



Engineers building the aircraft spars, supporting beams that run the length of the wings

How do jet engines work? The machines that turn fuel into thrust

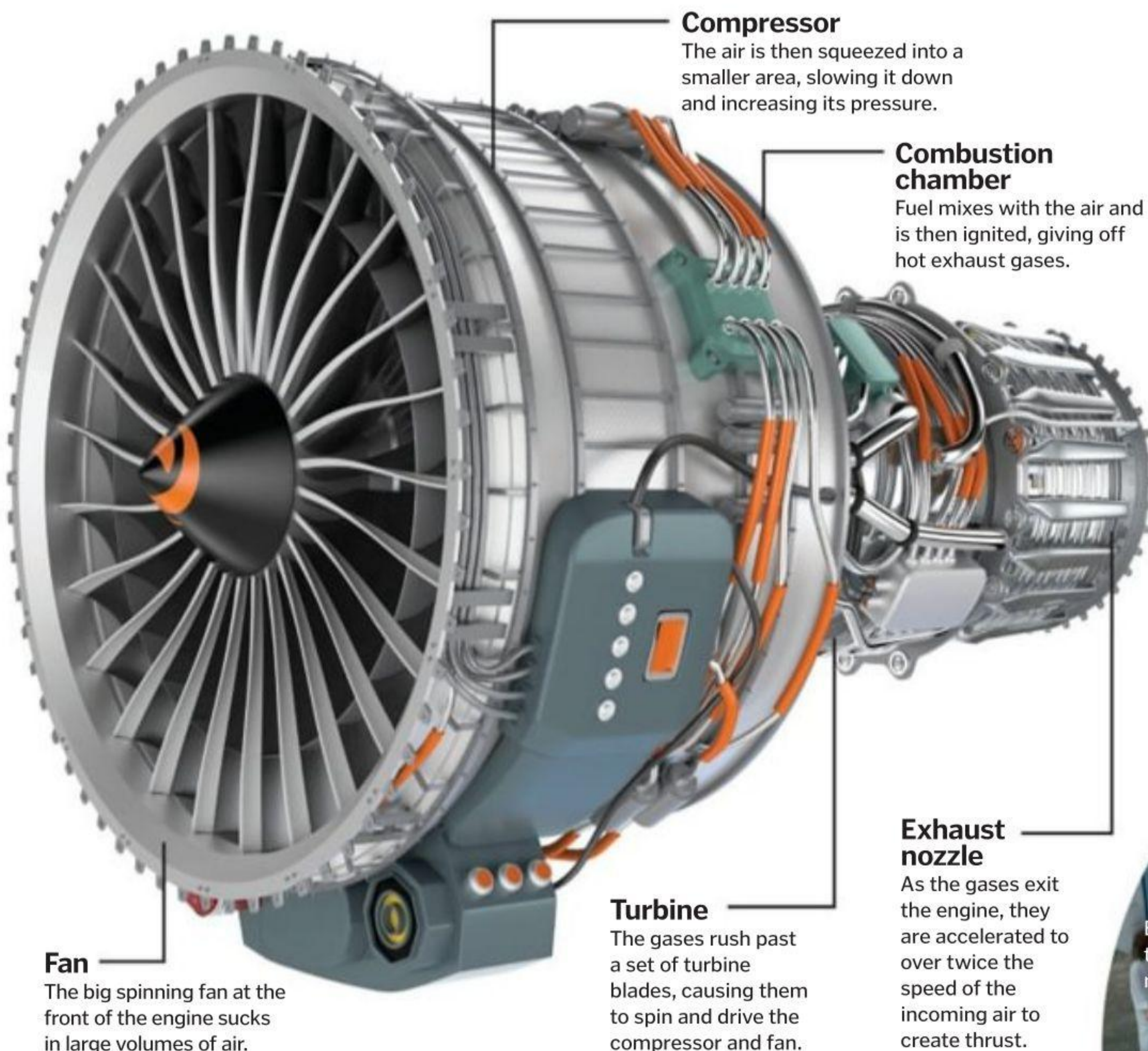

What is a plane made of?

The very first planes were built from wood and fabric, but thankfully modern aircraft are made of much stronger—and less flammable—stuff. Metal was once the material of choice, with strong, light aluminium used to build the main airframe and outer skin, but it was soon discovered to be corrosive and susceptible to stress.

Nowadays, manufacturers favour composite materials, which are stronger and more durable, yet still incredibly lightweight. To build the wings and fuselage of an aircraft, layers of carbon fibre and resin are built up, like layering several strips of sticky tape on top of each other.

The entire aircraft part is then placed in an enormous oven, called an autoclave, to harden the composite material until it becomes incredibly strong. Once it is complete, the windows and doors are cut out, and the whole thing is covered in a green protective coating, ready to be assembled.

What's in a plane?

The materials used to build a typical jumbo jet

10% Steel

Steel is stronger than aluminium so is used to build the landing gear.

5% Other

Plexiglass windows, fabric upholstery, and many other materials complete the aircraft.

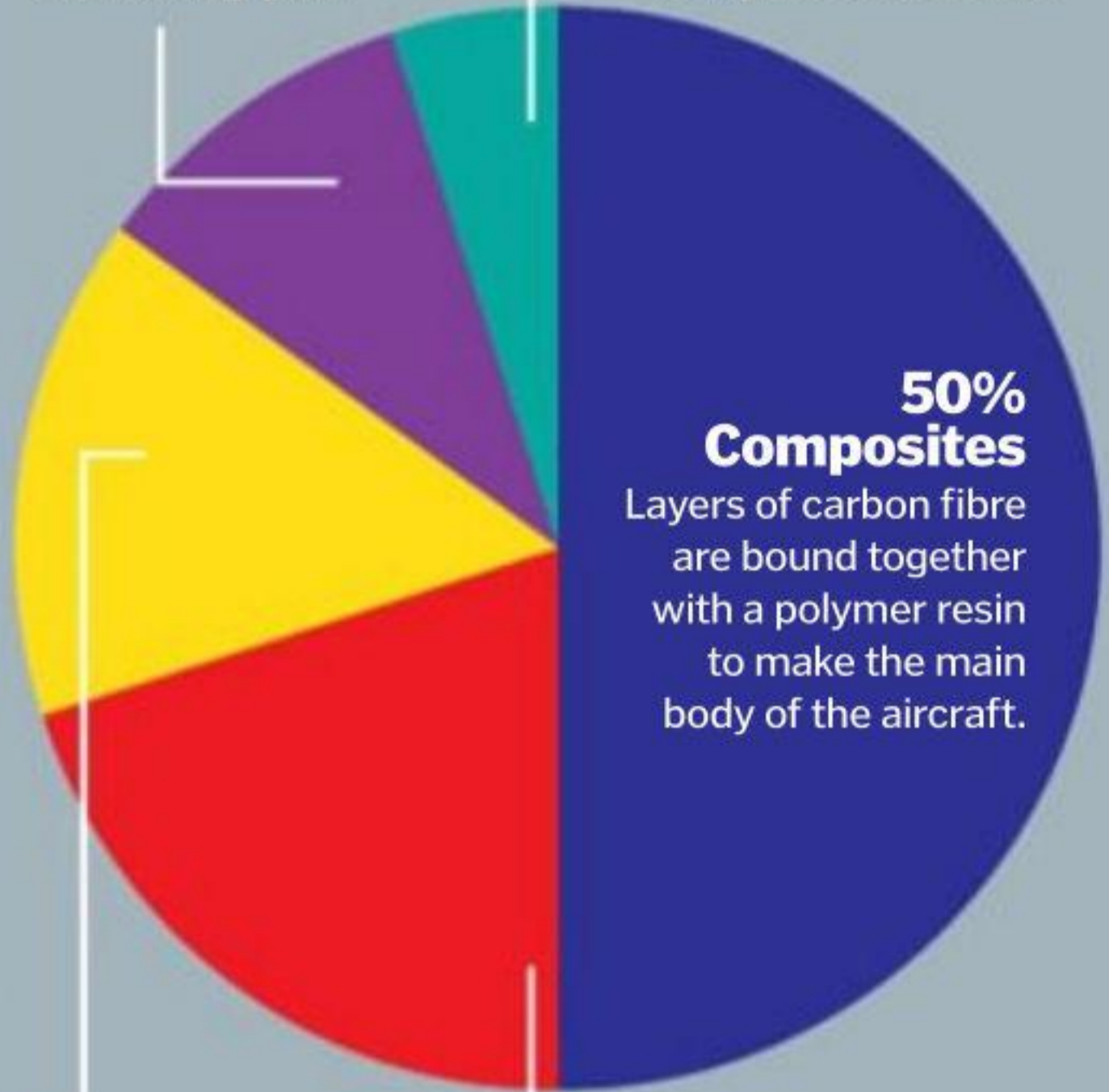

15% Titanium

Its ability to withstand high temperatures makes titanium a good choice for constructing the engines.

20% Aluminium

Lightweight and strong, aluminium is still the main metal of choice for many parts of an aircraft.



Enormous ovens are used to harden the composite material on an aircraft

© Credit



HOW IT WORKS

COMMERCIAL AIRCRAFT

How to build a plane

STEP 3: The final assembly

Putting together an enormous passenger jet requires an even more enormous building to do it in. Aircraft hangars are some of the largest buildings in the world, and are able to house several aircraft at once as they are passed from team to team along the assembly line.

First though, all the parts need to get there, and this is done by road, river and even air. Cargo aircraft such as the Airbus Beluga and Boeing Dreamlifter, are designed specifically to transport large pieces of aircraft to the final assembly point.

The individual pieces of the fuselage are fastened together using thousands of rivets, then the electrical and hydraulic systems, plumbing and insulation are installed. Next the wings are connected, using laser alignment to ensure they are perfectly level, and the landing gear is fitted underneath. This is followed by the tail, vertical stabilisers and an auxiliary power unit, which provides power to the aircraft when the engines are turned off. The cabin and cockpit interiors are then added, complete with seats and toilets.

Last of all, the engines are installed, as these are the most expensive component of the aircraft, representing over a third of its total value. Once assembly is complete, the plane is painted—this can take up to a week, depending on its size.

Planes are assembled in huge aircraft hangars by thousands of engineers



Aircraft slowly move along the assembly line as new parts are added



Giant cranes lift the parts of the fuselage in place, ready to be connected

775,000 square feet

The size of the Airbus aircraft hangar in Toulouse, France



The engines are fitted last, as they are the most expensive part of the aircraft



The Airbus Beluga cargo plane is so-called because it resembles a beluga whale

DID YOU KNOW? Some aircraft hangars are so big that air circulation systems are installed to prevent clouds from forming inside

STEP 4: In-flight testing

If the aircraft is a new design, then the first few planes to roll off the assembly line undergo extensive prototype testing. This involves fitting them with a variety of sensors, and flying in extreme conditions, such as very hot and cold climates and really high altitudes. The individual elements of the aircraft are also tested, as the wings are forcibly bent to evaluate their strength, and dead birds are fired into the engines to see how they would cope with a bird strike.

To ensure the plane can withstand the stress of multiple take-offs and landings, computer-operated hydraulic jacks place heavy loads on the airframe for extended periods of time, and the plane may even be subjected to artificial lightning strikes to see how it performs in a storm. Once the first few planes have been rigorously tested, all successive aircraft are taken on their own test flights before they are deemed airworthy and delivered to airlines around the world.

Ready for take-off!



Aircraft are tested on their ability to land on a waterlogged runway



Aircraft wings must be able to bend by nearly 90 degrees without being damaged





HOW IT WORKS

COMMERCIAL AIRCRAFT

Lineage 1000

"It can seat up to 19 passengers in upper-class comfort"

The luxury of the Lineage 1000 jet

A luxurious hotel in the sky? It's yours for a few million dollars

 The best private jets offer more than just rows of seating and the Lineage 1000 includes a shower room, a double bed, a lounge and an office, a bar and almost everything else you need in a space that is three times larger than traditional business jets. It can seat up to 19 passengers in upper-class comfort and the interior has been built to include five privacy areas, Wi-Fi and real-time flight displays, all thanks to the larger space and innovative interior design. On top of this the turbofan engine technology and fuselage interior design ensure low noise for passengers.

Safety has not been ignored and the pilot has a CMC (central maintenance computer) at hand to predict potential problems and offer solutions, plus an enhanced vision system to

improve awareness at all times. Many of the systems are integrated into the jet itself, rather than added on, which reduces weight, helping (along with other design enhancements) to increase the aircraft's approach steepness, which is ideal for landing in smaller airports.

One of these enhancements is Smart Probe, which will sense airspeed, trim and altitude to ensure the most accurate positioning at all times. To sum up, the Lineage 1000 offers the ultimate flying experience thanks to the designers pushing the envelope in every single area of the design process.

6. Preparing food

The galley area is where food and drinks will be prepared. It can be sealed off from the rest of the cabin so as not to ruin the ambiance.

4. Catch up

Multiple large displays offer entertainment, internet and other facilities which will keep you busy no matter how long the flight is.

5. Need a restaurant?

The dining area is the perfect way to enjoy your in-flight meal, which is highly unlikely to be served on plastic trays.

8. The serious stuff

Inside the cockpit are some seriously clever systems designed to aid safety and ensure the least disruption possible.

Filthy-rich airlines, you are clear for take off



What the opposite to economy class looks like!

LUXURIOUS



1. Falcon 7X

The Falcon 7X offers a mere 39-foot long cabin, but the advanced environmental systems still make for a very pleasant journey.

MORE LUXURIOUS



2. Gulfstream G650

The Gulfstream is designed to offer flexible comfort and succeeds, and at 53 feet offers great scope for individual cabin design.

MOST LUXURIOUS



3. Embraer Lineage 1000

With a cabin length of 84 feet the Lineage 1000 is easily the most luxurious thanks to the comfort and individualism offered in every corner.

DID YOU KNOW? The Lineage 1000 interior can be configured from 25 different cabin modules



Pure airborne luxury

1. Stay awake

The 84 foot long cabin offers a huge amount of space, which can be configured into various private areas for maximum comfort.

2. Get some sleep

A double bed will ensure you catch up on the sleep you need or you can just lie back and enjoy the large display on the wall.

9. The power

The turbofan engines ensure the quietest and smoothest possible flight and also offer a longer range than many other private jets.

7. More than a wardrobe

The 351 cubic feet walk-in baggage compartment lets you take your entire wardrobe with you and there's still room for your other luxuries.

3. Freshen up

A fully equipped luxurious bathroom will help you arrive at your destination fresh as a daisy and the fittings rival the best hotels.



The statistics...

Lineage 1000
Manufacturer: Embraer
Class: Heavy jet
First flight: October 26, 2007
Wingspan: 94ft
Length: 119ft
Height (outside): 34ft
Cabin height: 6.5ft
Cabin volume: 4,085ft ³
Cabin area: 226ft
Weight max payload: 121,254lb
Max speed/cruise speed: 480 knots/469 knots
Propulsion: GE CF34-10E turbofans (x2)
Ceiling: 7,765mi

Know your engines

Jet engines are almost universally used to power private jets and passenger aircraft, but there are some significant differences between the type used on each. Private jets often use high-bypass turbofans, which are very quiet and offer enhanced fuel efficiency plus excellent thrust to ensure better performance. These engines are usually placed below the wing to reduce drag and turbulence, particularly during take off, which is crucial for a small passenger plane. Tests have proved that turbofan engines are highly reliable and that most pilots should never suffer an engine incident in their entire career. The Gulfstream G550 is one example which is powered by twin Rolls-Royce turbofans.



© Gulfstream Aerospace Corp

Know your jets



Class: VLJ
Passengers: 4-8

The VLJ (very light jet) is often used as an air taxi to travel between local airports in a country.



Class: Light jets
Passengers: 5-9

Light jets are similar to VLJs in their target market, but are faster and offer some extra luxuries for quick journeys.



Class: Mid-size jets
Passengers: Up to 18

Mid-size jets typically carry eight to 12 people, but some can accommodate 18 people for short flights.



Class: Super mid-size jets
Passengers: Up to 19

These jets are designed to offer luxury for transatlantic flights and give more cabin space and luxuries.



Class: Large size jets
Passengers: Up to 19

Large size jets are designed for longer distances and New York to Tokyo is quite possible with high levels of comfort.



Class: Heavy jets
Passengers: 100s

Heavy jets range in size and can be privately hired. The Lineage 1000 is in this class, but is small compared to some.



HOW IT WORKS

COMMERCIAL AIRCRAFT

The largest passenger jet



The Airbus A380 is greener and quieter than many other passenger jets

Thrust reversers

Located on the innermost engines, these slow down the aircraft to assist the brakes when landing on a wet runway.

Lightweight materials

The majority of the wings and fuselage are made from aluminium alloys, but 25 per cent of the structural weight is composite materials.

Cabin comfort

220 cabin windows provide plenty of natural light and the cabin air is recycled every two minutes for a fresh atmosphere.

Boarding the A380

The incredible technology inside this sky giant

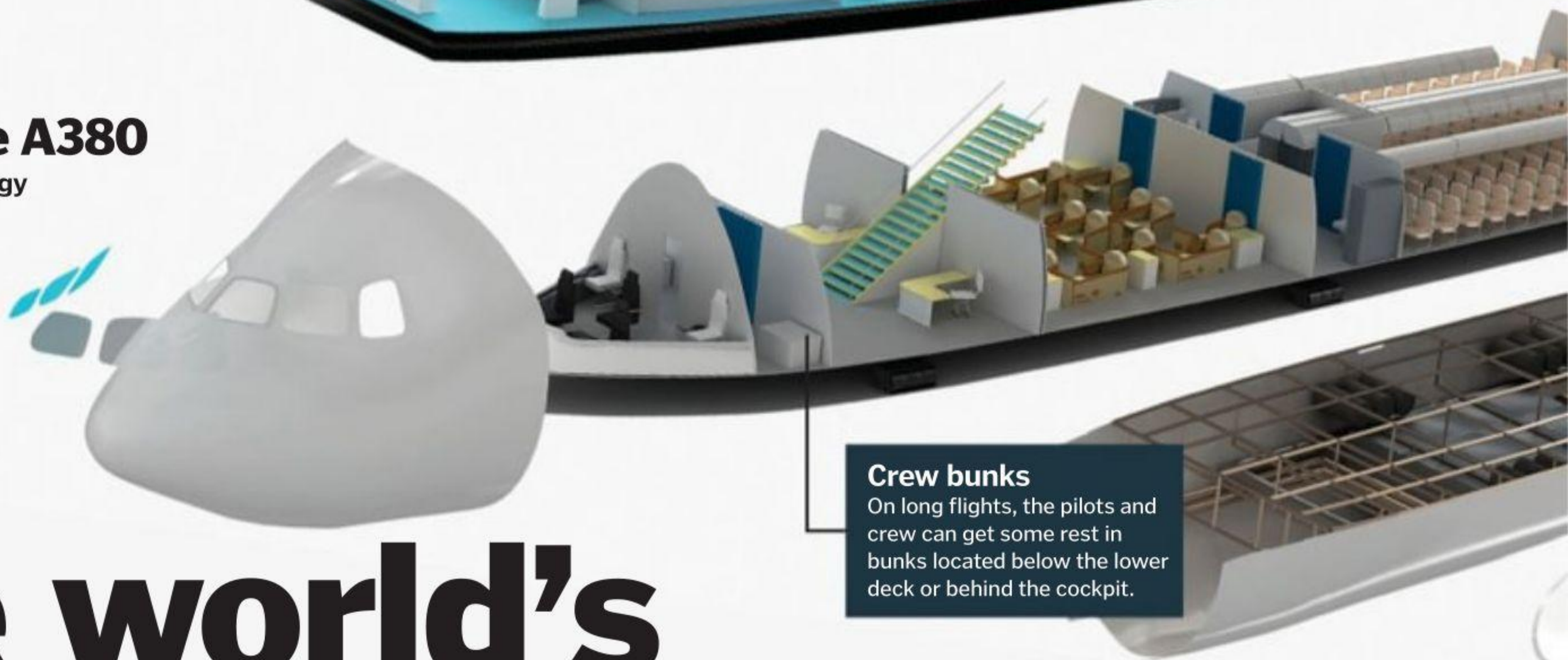

Crew bunks

On long flights, the pilots and crew can get some rest in bunks located below the lower deck or behind the cockpit.

The world's largest passenger jet

How does the enormous double-decker Airbus A380 get off the ground?



Ferrying travelers all over the globe is an expensive business for the world's airlines, so it makes sense that they would want to pack as many passengers as possible onto each aircraft, reducing the number of flights they need to make. Thanks to its double-decker design, the Airbus A380 is capable of carrying up to 853 passengers at a time, if it is in a

single-class cabin configuration. That's over 150 more than the aircraft's competitor, the Boeing 747-8. Most A380s, however, feature four separate classes, with economy and premium economy on the lower deck and the more spacious business and first class upstairs, which reduces the passenger number to 544. This is still a 40 per cent increase on the 747-8's four-class capacity.

As well as being the largest passenger jet, the A380 is one of the quietest, with dampeners reducing engine noise to half that of other jets. It is also more environmentally friendly, because it needs to take fewer flights to deliver the same amount of passengers, and the fuel-efficient engines are claimed to give off 22 per cent fewer CO₂ emissions than the jet's closest competitor.

DID YOU KNOW? The Airbus A380 is covered in three layers of paint weighing around 1,100 pounds

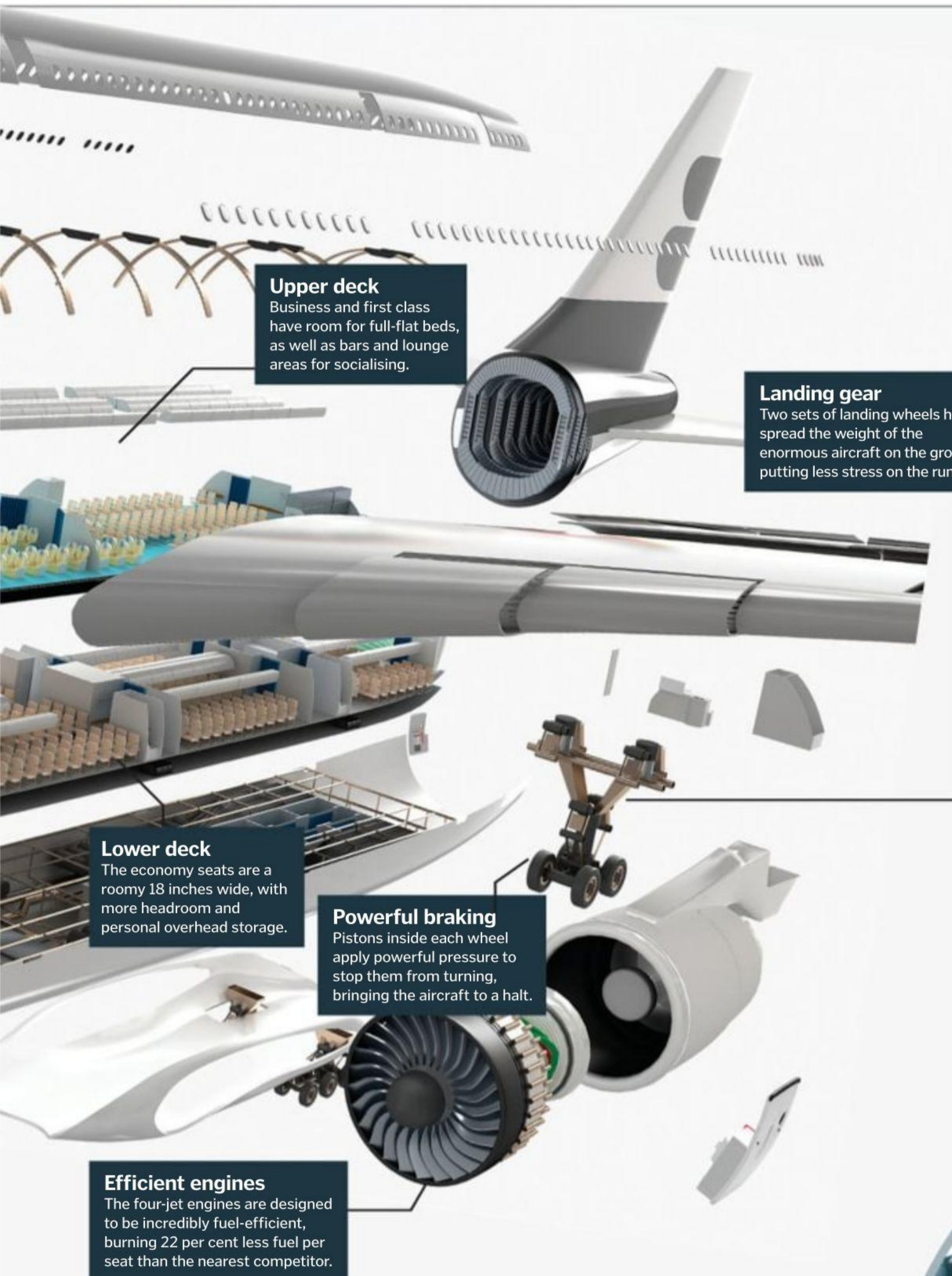

Upper deck
Business and first class have room for full-flat beds, as well as bars and lounge areas for socialising.

Landing gear
Two sets of landing wheels help to spread the weight of the enormous aircraft on the ground, putting less stress on the runway.

Lower deck
The economy seats are a roomy 18 inches wide, with more headroom and personal overhead storage.

Powerful braking
Pistons inside each wheel apply powerful pressure to stop them from turning, bringing the aircraft to a halt.

Efficient engines
The four-jet engines are designed to be incredibly fuel-efficient, burning 22 per cent less fuel per seat than the nearest competitor.



Two staircases provide access to the aircraft's upper and lower decks

Next-gen flight deck
The cockpit of the A380 is designed to be very similar to that of other Airbus aircraft, minimising the amount of time that pilots have to spend training to fly it. It features an instrument panel with eight large, interactive liquid crystal display units showing navigation, engine and systems information, as well as a transparent head-up display that superimposes information over the pilot's view. An electronic library also replaces the traditional paper documentation used by pilots, allowing them to locate operational information more easily and analyse the aircraft's performance. As the plane prepares for landing, the process is made easier as the flight crew can pre-select the optimum runway exit at their destination airport, and leave the autopilot to regulate deceleration after touchdown accordingly. This helps to reduce runway occupancy time and therefore increase the number of aircraft the airport can handle at any given time.

The A380's cockpit is designed to make Airbus pilots feel at home

© Airbus/Getty



Building an aircraft of this enormous size does present a few problems, though. Many airlines have had to modify their aircraft hangars to accommodate the increased height and wingspan of the A380, and some airports just don't have enough space for them to park. Also, to speed up the process of boarding and offloading such a large number of passengers, two

gangways from the aircraft to the terminal building are needed – a set-up that only certain airports are capable of. As a result, the A380 can usually be found traveling to and from the world's biggest international airports, making the most of its 9,445-mile range to deliver passengers to far-flung destinations in style.



HOW IT WORKS

COMMERCIAL AIRCRAFT

Solar-powered aircraft

Solar-powered aircraft

The flying machines that are fuelled only by the Sun



As the search for renewable and carbon-neutral forms of energy intensifies, solar energy is leading the way in fuelling the next generation of aircraft and cleaner travel.

One aircraft breaking boundaries in this area is the Solar Impulse 2. This incredible machine is set to launch a non-stop, round-the-world trip powered only by the Sun. It will do this by using 236-foot wide wings, each of which will be carrying over 8,500 solar cells, powering four electric motors and four lithium batteries. Despite this astonishing wingspan, the entire aircraft will only weigh 5,071 pounds, which is about as heavy as a large great white shark.

Another major player in the world of solar powered aviation is Solar Flight. Their newest project is Sunseeker Duo, which is the only two-seater solar-powered airplane in operation. It follows a similar pattern to the Solar Impulse 2, with long wings covered with solar panels and a lightweight body. Its panels have been improved to become 50 per cent more efficient than their predecessors. It can fly for 12 hours and its engine produces 25 kilowatts (33.5 horsepower) of power.

The main question with using solar power is 'what happens at night?' During the day, not all the energy is used. Enough will be stored in the batteries to allow the aircraft fly at night.

The next challenge for solar-powered aviation is to be able to carry multiple passengers, so hopefully one day soon vacationers will be able to use the Sun on their way to soaking it up.

How solar panels work

We have heard a lot about solar panels converting sunlight to energy, but how does that process actually work? Inside a solar panel is a number of silicon cells that are placed on top of each other. One of the silicon atoms has all its electrons, while the one beneath it has a few missing. In order to restore the balance, the full silicon atom transfers electrons to the one below, but it needs light to trigger the process. Once the sunlight hits the panel, electrons are transferred from one silicon cell to the other, thereby creating an electric current that powers a load.



Anatomy of a solar aircraft

How the Solar Impulse 2 gets off the ground and stays there

Wings

The wingspan of the plane is a total of 236ft, stretching wider than a jumbo jet's wings.

Batteries

There are four rechargeable lithium polymer batteries inside the plane, weighing a total of 1,396lb that provide the 50kW (70hp) power.

Insulation

To keep the pilot from suffering in the 104°F to -40°F temperature change the cockpit uses advanced thermal insulation.

The cockpit

The cockpit is only 134ft³, so it will be fairly cramped but essential for the lightweight design.

Lift

The plane will rise to 27,887ft during the day to make the most of the power and then drop to 4,921ft at night.

DID YOU KNOW? In 2013, the original Solar Impulse prototype flew across the USA without a single drop of fuel

Despite the massive wingspan, the Solar Impulse weighs about the same as two small cars



Close up power

When it was launched on February 10, 2020, ESA's Solar Orbiter received a ridiculous boost of solar energy as it began its mission to get closer to the Sun than any probe had before and take incredible pictures of the star. With its 10.2-foot x 7.9-foot sunshield, this craft will travel just 26 million miles away from the Sun to take high-resolution images and perform experiments. It has been rigorously tested, as it will experience temperatures ranging from 968 degrees Fahrenheit to -274 degrees Fahrenheit. Its aim is to help scientists learn more about the inner heliosphere and how solar activity affects it, answering questions about solar winds, coronal magnetic fields and solar eruptions.

Airframe

It is constructed from incredibly strong, yet lightweight materials such as carbon fibre in a honeycomb pattern.

Speed

The plane can travel at a top speed of 87mph.

Panels

There are a total of 17,000 solar panels, each drawing in energy from the Sun to power the plane and charge the batteries.

Motors

There are four electric 13kW (17.5hp) engines, each about the same as a small motorbike.

Propellers

These propellers provide the main thrust behind the plane, rotating at different speeds to steer.



HOW IT WORKS

COMMERCIAL AIRCRAFT

Cargo planes

On board a cargo plane

How do freight aircraft differ from passenger planes, enabling them to transport much greater loads all over the planet?



Cargo planes—whether used in the private, military or commercial sphere—are fixed-wing vehicles that have usually been designed with haulage in mind or have been converted from standard aircraft. Passenger planes commonly have a specialized hold that can store over 5,000 cubic feet of freight, found on the underside of the craft. Dedicated freight planes don't need the seats or any of the other amenities on commercial flights—that said, their design amounts to much more than a hollowed-out passenger plane. To make the most efficient use of the space available, the floor is lined

with a walkway and electronic rollers that allow prepackaged pallets to be rolled back as far as possible, without the need for a forklift. Large cargo bay doors are installed to fit bigger items through and, in some examples, like the Boeing 747-400, the nose lifts up to allow particularly large items to pass down the body of the plane.

With the demands of air freight ever increasing, aircraft with huge cargo capacities like the Airbus A300-600 Super Transporter (also known as the Beluga), are becoming the norm. It's not enough just to increase

the size of the aircraft hold though. In order for a cargo plane to efficiently and safely transport its mighty load, a number of adaptations must be made to the overall avian design. For example, the wings and tail are built high to allow the freight to sit near the ground and to facilitate loading; the fuselage is much bigger; and—similar to heavy goods vehicles—cargo planes typically feature a larger number of wheels to support their weight on landing.

Plane politics

The Xian Y-20 is a military long-range transport plane developed by China that entered service in 2023. It's a similar class of aircraft as Russia's Ilyushin Il-76 or the US Boeing C-17, and though China maintains a tighter guard over its military secrets than most, it has an estimated payload in the region of 160,000 pounds—that's quite a bit, by any country's standards! The PLAFF (People's Liberation Army Air Force), or avian branch of the Chinese military, had long favoured the development of fighter jets over this kind of support aircraft, so much so that the Y-20 project was sidelined when it started in 2005. However, following the Sichuan earthquake of 2008, China was unable to effectively drop relief supplies with its small fleet of cargo planes, so the USA had to assist with two C-17s. This embarrassment undoubtedly spurred the Chinese government into pushing on with the Y-20's development.

Cargo plane credentials

HIW pinpoints what a military cargo transporter needs to get the job done



Engine

Four turbofan jet engines can provide as much as 43,000lbf of thrust.

Lightening the load

Depending on the type of cargo being carried (very large items or military vehicles may be exceptions), many cargo planes will use ULDs, or unit load devices. These allow the crew to prepackage cargo into single units that can more easily be loaded into the hold prior to the flight, saving a great deal of time. It's a similar system to that used in shipping, maximising the space used at the same time and, thus, increasing efficiency (and profits). The ULDs themselves are either robust and lightweight aluminium pallets or aluminium-floored containers with toughened plastic walls. The containers are sometimes converted into self-contained refrigeration units to store perishable goods.



The cargo bay of a freightliner, including a conveyer belt for hauling goods

Vehicle ramp

Large aircraft (like Lockheed's C-5 Galaxy) are quite capable of carrying several light vehicles which can be driven on via ramps.

**RECORD
BREAKERS**
LARGEST PAYLOAD

250 tons

WORLD'S BIGGEST CARGO PLANE

This title goes to Russia's Antonov An-225 Mriya. It has a wingspan roughly the length of a football pitch, can carry four tanks in its cavernous hold and has space for up to 80 cars.

DID YOU KNOW? Passenger planes have been used to carry mail since 1911 and still do to this day



Lockheed Martin's C-5 Galaxy has 12 internal wing tanks with a total capacity of 42,755 gallons of fuel

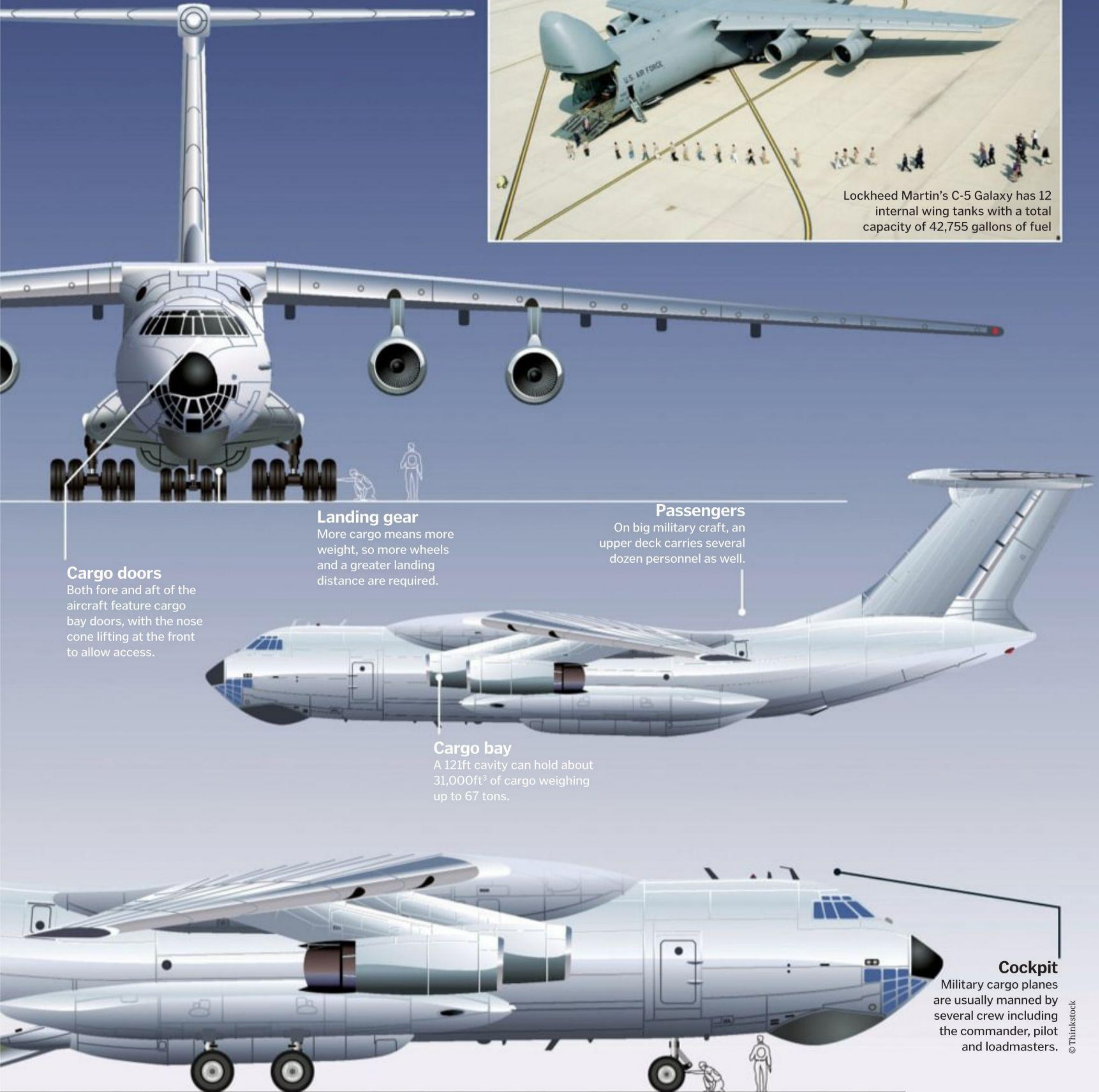

Cargo doors

Both fore and aft of the aircraft feature cargo bay doors, with the nose cone lifting at the front to allow access.

Landing gear

More cargo means more weight, so more wheels and a greater landing distance are required.

Passengers

On big military craft, an upper deck carries several dozen personnel as well.

Cargo bay

A 121ft cavity can hold about 31,000ft³ of cargo weighing up to 67 tons.

Cockpit

Military cargo planes are usually manned by several crew including the commander, pilot and loadmasters.

© Thinkstock



HOW IT
WORKS

COMMERCIAL AIRCRAFT

787 Dreamliner



Boeing 787 Dreamliner

This new jetliner promises to transform the commercial airliner industry, boasting significantly improved fuel economy and a host of next-gen features. We take a closer look...



At first glance the Boeing 787 Dreamliner appears to be nothing special. A new mid-sized jetliner that through its conventional design, standard power output and modest maximum range seems to, for the most part, blend in with the crowd. Just another commercial passenger jet introduced to a market hit severely by the worldwide recession. A multimillion pound piece of technology that changes nothing. But if you believe that, then you couldn't be more wrong...

That is because, as is common with most groundbreaking new technologies and ideas, the devil is in the details. Indeed, the Boeing 787 is arguably a slice of the future today, both literally (its service life is predicted to extend up to 2028) and metaphorically. The latter comes courtesy of it being the first aircraft to be designed within a mantra of

efficiency over everything else. That's not to downplay the aircraft's numerous new improvements and technological advancements in any way—this is one of the most complex jetliners currently in operation in the skies—but in the present financial climate and arguably one that will affect the industry for years to come, this greener, cheaper and more accommodating aircraft is laying down a roadmap that others can now follow.

The evidence for this? How about the worldwide orders of 821 new planes from 57 operators to the tune of \$145 billion?

So how is the 787 turning the dream of cheaper, more efficient air travel into a reality? The simple answer is a direct 20 per cent saving on both fuel usage and outputted emissions. The long answer is a little more complicated.

The key to the super-high performance granted by the Dreamliner lies in its adoption of a suite of new technologies and materials. Composite materials (ie carbon-fibre/reinforced carbon-fibre plastics) make up 50 per cent of the primary structure of the 787, which include both the fuselage and the wings. These are lighter, stronger and more versatile than traditional pure-metal offerings. Indeed, when this model is compared against the Dreamliner's predecessor, the Boeing 777—read: a mere 12 per cent composite materials and over 50 per cent aluminium—you begin to grasp what a game-changer this vehicle is to the jetliner industry.

The new materials have been partnered with a completely revisited build process, which allows each Dreamliner to be produced from fewer aluminium sheets, less fasteners (an 80 per cent

5 TOP FACTS

BOEING 787 DREAMLINER

Rollout

1 The Boeing 787 Dreamliner was first unveiled on July 8, 2007 in Washington, USA. By the time of its unveiling it had already accrued 677 orders from companies worldwide.

Big brother

2 The 787 got a big brother in 2013, with a larger-elongated-variant of the Dreamliner first in production. This has a capacity for 290 passengers.

Fat boy

3 The initial assembly of the 787 did not go smoothly, with the aircraft coming in overweight by about 5,000lb. Boeing used lighter titanium to reduce this excess.

Assembly

4 Until 2011, the final assembly of all 787s was at the Boeing factory in Everett, WA. Since last year, however, the aircraft have also been put together at North Charleston, SC.

First

5 The first Dreamliner to be officially delivered was to All Nippon Airways in September 2011. ANA is one of Japan's largest airlines, operating to 35 global locations out of Tokyo.

DID YOU KNOW? The Boeing 787 consumes 20 per cent less fuel than the similarly sized 767v



More than 50 companies have worked on the 787, each connected virtually at 135 sites worldwide



787 cabin layouts can be split into one of three configurations, prioritising capacity or class divisions

The statistics...



Boeing 787 Dreamliner

Crew: 2
Length: 186ft
Wingspan: 197ft
Height: 56ft
Max weight: 502,500lb
Cruise speed: 647mph
Max range: 9,440mi
Max altitude: 43,000ft
Powerplant: 2 x General Electric GENx / Rolls-Royce Trent 1000

reduction on the 777) and simpler drill schematics—the latter allowing a 787 to have fewer than 10,000 holes drilled in its fuselage (the 747 needed over 1 million, a truly staggering amount). This saves on production costs, assembly time and streamlines the build, reducing potential points of failure, while increasing aerodynamic efficiency. In addition, more than 60 miles of copper wiring has been eliminated from the new model, again saving weight and costs, not to mention streamlining the electrical infrastructure.

Talking of electronics, the Dreamliner has been designed with a state-of-the-art, fully electronic architecture, which through the replacement of all bleed air and hydraulic power sources with electrically powered compressors and pumps, extracts as much as 35 per cent less power from its engines at any one time. Further, a new electrothermal wing ice protection system—with moderate heater mats located on wing slats—improves de-icing levels and consistency significantly, again boosting aerodynamic performance. Wing lift

performance is also improved thanks to the adoption of raked wingtips, which reduce the thrust needed by the engines.

These efficiencies combine with the heart of the Dreamliner: its twin next-generation, high-bypass turbofan engines. Two engine models are used on the 787—both the General Electric GENx and Rolls-Royce Trent 1000—each delivering a maximum thrust of 280 kilonewtons (64,000 pounds force) and a cruise speed of Mach 0.85 (647 miles per hour). Both engines are designed with lightweight composite blades, a swept-back fan and small-diameter hub to maximize airflow and high-pressure ratio—the latter, when complemented by contra-rotating spools, improving efficiency significantly. Finally, both engines are compatible with the Dreamliner's noise-reducing nacelles, duct covers and air-inlets. Indeed, the engines are so technologically advanced that they are considered to be a two-generation improvement over any other commercial passenger jet.

As such, contrary to initial appearances, the Dreamliner is really a

wolf in sheep's clothing, delivering standard-bearing improvements, along with a vast list of incremental ones—including energy-saving LED-only lighting—that make it one of the most advanced and future-proofed jets in our skies today. And you know what is most exciting? Judging by Boeing's current substantial backlog of sales, there is a high probability that you will be flying on one of these mighty machines yourself in the near future.



A General Electric GENx high-bypass turbofan jet engine, one of two used on the Dreamliner



HOW IT WORKS

COMMERCIAL AIRCRAFT

787 Dreamliner



Cockpit

The Dreamliner's state-of-the-art cockpit is fitted with Honeywell and Rockwell Collins avionics, which include a dual heads-up guidance system. The electrical power conversion system and standby flight display is supplied by Thales and an avionics full-duplex switched ethernet (AFDX) connection transmits data between the flight deck and aircraft systems.

Electronics

The 787 features a host of LCD multifunction displays throughout the flight deck. In addition, passengers have access to an entertainment system based on the Android OS, with Panasonic-built touchscreen displays delivering music, movies and television in-flight.

The first completed Dreamliner was delivered to All Nippon Airways in 2011



Anatomy of the Dreamliner

We break down a Boeing 787 to see how it outpaces, out-specs and outmaneuvers the competition

Cargo bay

The standard 787—referred to as the 787-8—has a cargo bay capacity of 4,400ft³ and a max takeoff weight of 503,000lb. The larger variant—referred to as the 787-9—has a cargo bay capacity of 5,400ft³ and a max takeoff weight of 545,000lb.

Flight systems

The 787 replaces all bleed air and hydraulic power sources with electrically powered compressors and pumps. It is also installed with a new wing ice protection system that uses electrothermal heater mats on its wing slats to mitigate ice buildup. An automatic gust alleviation system reduces the effects of turbulence too.

Wings

The 787 Dreamliner's wings are manufactured by Mitsubishi Heavy Industries in Japan and feature raked wingtips. The raked tips' primary purpose is to improve climb performance and, as a direct consequence, fuel economy.

Engines

Two engine models are compatible with the Dreamliner: twin General Electric GENx or Rolls-Royce Trent turbofans. Both models produce 280kN (64,000lbf) and grant the 787 a cruising speed of 647mph. They are also compatible with the jet's noise-reducing nacelles, duct covers and exhaust rims.

Evolution of the jetliner

We select some of the high points in the development of the commercial jetliner

1945 Vickers VC.1 Viking

A British short-range airliner derived from the Wellington bomber, the Viking was the first pure jet transport aircraft.

1952 DH-106 Comet

The Comet was the world's first commercial jet airliner to reach production. It was developed by the de Havilland company in England.

1955 SE-210 Caravelle

The most successful first-generation jetliner, the Caravelle was sold en masse throughout Europe and America. It was built by French company Sud Aviation.

1958 Boeing 707-120

The first production model of the now-widespread 707 series, the 707-120 set a new benchmark for passenger aircraft.

1961 Convair 990

A good example of a narrow-body jetliner, the 990 offered faster speeds and greater passenger-holding capacity.

1976 Aérospatiale-BAC Concorde

A standout development in the second generation of jetliners, the Concorde delivered supersonic, transatlantic flight—something unrivalled even to this day.



1. Boeing 787-10
The largest Dreamliner, which entered service in 2018, can seat up to 310 passengers when it is configured for highest seat quantity.



2. Boeing 747-400
A significant redevelopment of the 747, the 747-400, when specced out for max number of seats, can carry up to 524 passengers.



3. Airbus A380
So big that a new term had to be coined in order to classify it—superjumbo—the A380 has two decks and can carry up to a monumental 853 people!

DID YOU KNOW? To date, over 800 Boeing 787 Dreamliners have been ordered by airlines all around the world



A stand-up, fully stocked bar is available on each 787

Amenities

When on board passengers are offered roomier seats (across all classes), larger storage bins, manually dimmable windows, a stand-up bar, gender-specific lavatories and an on-demand entertainment system. First-class passengers receive a complimentary in-flight meal and, on international flights, fully reclinable seats for sleeping.

Cabin

The standard 787 is designed to seat 242 passengers across a three-class arrangement, with 182 seats in economy, 44 seats in business and 16 seats in first. Cabin interior width rests at 18ft and on either side is lined with a series of 11 x 19-inch auto-dimming windows.

Fuselage

The 787 is constructed from 80 per cent composite materials (carbon fibre and carbon-fibre reinforced plastic) by volume. In terms of weight, 50 per cent of the materials are composite, 20 per cent aluminium, 15 per cent titanium, 10 per cent steel and 5 per cent other.

Compatibility

The 787 Dreamliner is designed to be compatible with existing airport layout and taxiing setups. As such the 787 has an effective steering angle of 65 degrees, allowing it to rotate fully within a 42m (138ft)-wide runway. It also has a 32m (100ft) tyre edge-to-turn center ratio.



Train to gain

Boeing has gone the extra mile to produce a complete package with the 787 Dreamliner, offering state-of-the-art simulation facilities for pilots to get up to speed

Potential 787 pilots can utilize Boeing's revolutionary full-flight simulator to train for real-world flights and specific context-sensitive scenarios. Currently there are eight 787 training suites at five Boeing campuses worldwide, located from Seattle through to Tokyo, Singapore, Shanghai and on to London Gatwick. The simulators, which are produced by French electronic systems company Thales, include dual heads-up displays (HUDs) and electronic flight bags (EFBs), and are designed to train pilots to become proficient in visual maneuvers, the instrument landing system (ILS) and non-ILS approaches. Further, missed approaches using integrated specialist navigation, non-standard procedures with emphasis on those affecting handling characteristics, plus wind shear and rejected takeoff training can also be undertaken.

All of the training simulators are approved by the US Federal Aviation Administration (FAA), making them officially some of the most advanced training suites around right now.

Pilots and potential pilots can train at eight simulators worldwide



1986 Fokker 100

The Fokker 100 was a short-haul specialist that carried up to 100 passengers. Domestic and short-range international flights were its remit.

1994 Boeing 777

The first computer-designed commercial jetliner, the 777 delivered a vast 300-seat capacity and range (10,793 miles). It became a mainstay of airlines worldwide.

2005 Airbus A380

Since its launch in 2005 the Airbus has been the largest passenger aircraft in the world. The A380 has two decks and, when specced out for all economy-class seating, can carry 853 passengers.

2011 Boeing 787 Dreamliner

The most fuel-efficient jetliner of its class, the 787 has been designed to reduce the cost of air travel, while delivering a range of next-gen tech.



HOW IT
WORKS

COMMERCIAL AIRCRAFT

Hypersonic flight

5 TIMES THE SPEED OF SOUND

HYPERSONIC FLIGHT

Inside the planes that will
smash supersonic records



DID YOU KNOW? The crack of a whip is actually a sonic boom—the end of a whip can reach Mach 2



Blink and you'll miss them, but you'll definitely hear them. Hypersonic aircraft may look similar to the jet planes we're familiar with, but these engineering marvels are completely different beasts. Able to attain speeds that would literally tear a conventional passenger jet apart, hypersonic aircraft possess unique engines, are built from advanced materials and are packed full of intelligent tech.

So just how fast are they? By definition, a supersonic vehicle can move faster than the speed of sound—or Mach 1—which is 767 miles per hour, or 1,125 feet per second. But to be classed as hypersonic, planes must fly at least five times this speed—3,837 miles per hour, or 5,627 feet per second. And their speed isn't limited to Mach 5;

that's just the beginning. We've already created aircraft that can reach Mach 20—that's nearly four miles per second! As long as these vehicles can withstand the pressure in the atmosphere, they can keep moving faster and faster.

For over 30 years we were able to use Concorde to fly at supersonic speeds. It broke through the sound barrier and revolutionized air travel. But now the aim is to go faster than ever, with jets and commercial airliners capable of reaching even greater speeds.

This is, of course, no simple task, but little over a century after the Wright brothers first took to the skies we're still building new and innovative

aircraft. This technology reveals new realms of possibility that would make air travel more efficient and convenient than ever before. Imagine traveling halfway around the world in just a few hours, or seeing a spacecraft climb into the upper atmosphere without the need for a gigantic rocket.

The most exciting part is that this isn't the stuff of science fiction—we've already flown vehicles at hypersonic speeds, and researchers are now developing hypersonic planes suitable for public use. Read on for more of these incredible feats of engineering and the faster world that awaits us.

"Hypersonic aircraft attain speeds that would tear a conventional passenger jet apart"

Hypersonic vs supersonic

For many years experts believed it was simply impossible to fly faster than the speed of sound. But that all changed in the 1940s when US test pilot Chuck Yeager flew faster than Mach 1—the speed of sound—for the first time in human history. Onlookers below heard the sonic boom as the pressurized air gave way to the Bell X-1 rocket plane, and they realized that supersonic aircraft were dealing with new extremes.

Although supersonic aircraft have to overcome many obstacles to break the sound barrier, these factors are compounded when moving at hypersonic speeds. At Mach 5 and above the air does more than just form shock waves. At such high speeds the air heats the surface of the aircraft to very high temperatures—enough to melt steel—and the engines have to cope with huge pressures too.

What causes a sonic boom?

Why breaking through the sound barrier is such a noisy affair

Continuous boom

An aircraft traveling faster than Mach 1 is constantly producing shock waves, which merge to form a cone. In certain conditions, this is visible as a conical cloud of water vapour.

Around 75 passengers could be transported at Mach 10 inside the Skreemr



Below Mach 1

The aircraft compresses the air in front as it moves forward and emits noise from its engines, forming waves that move away at the speed of sound.

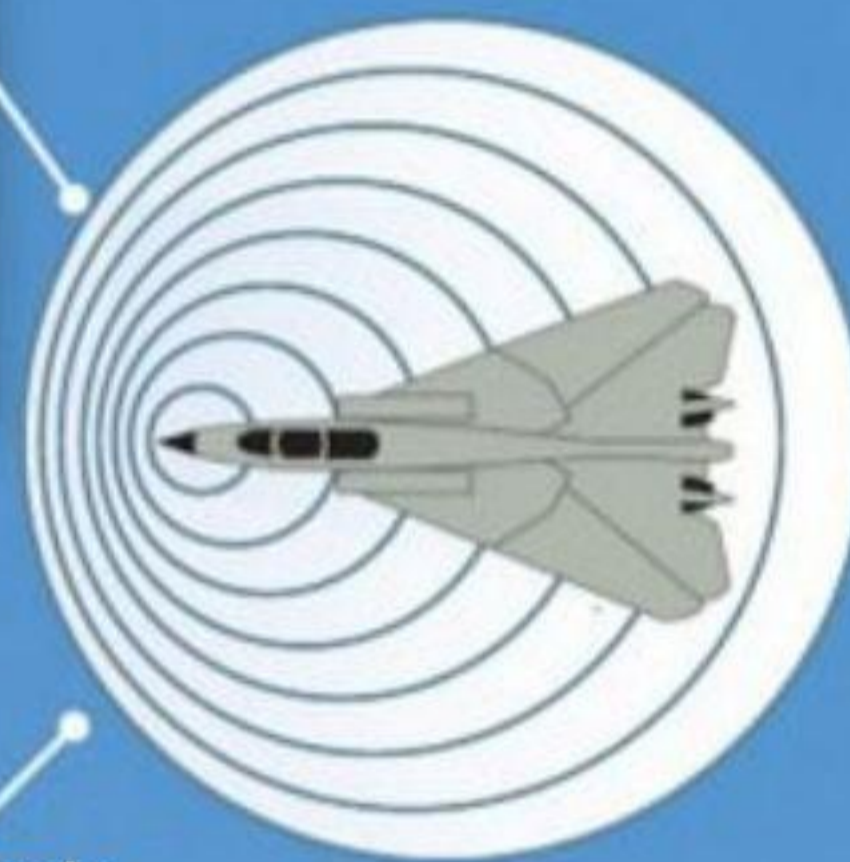

SUBSONIC SPEED

Wavefronts

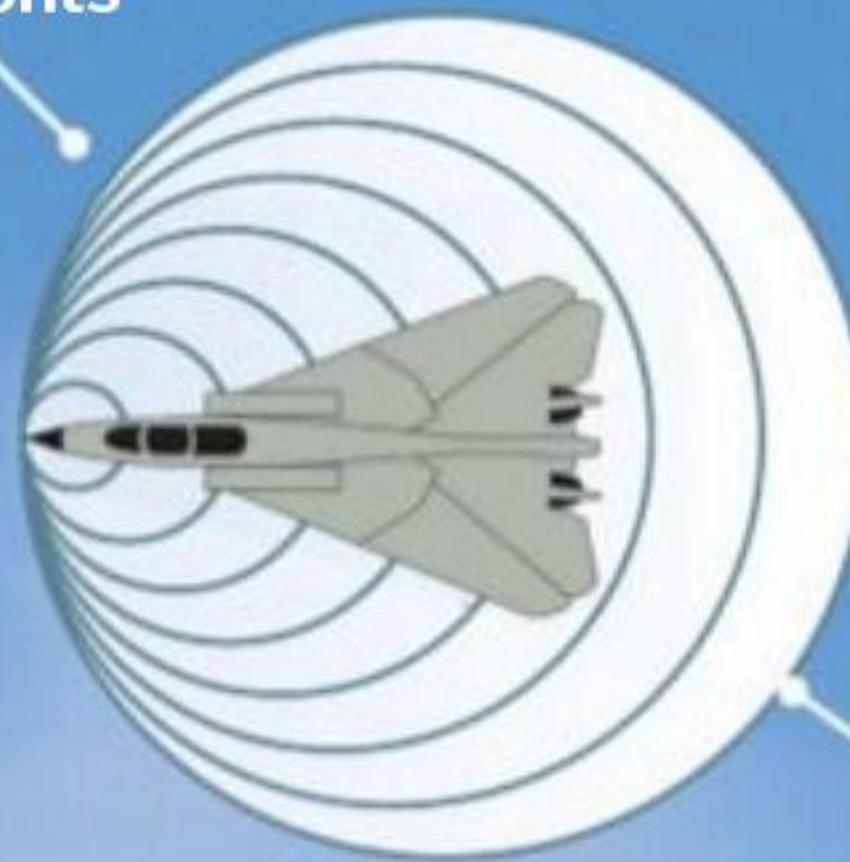

MACH 1

At Mach 1

When the aircraft reaches the speed of sound, the air being compressed cannot move away fast enough, so the waves accumulate at the nose of the plane.

Shock cone

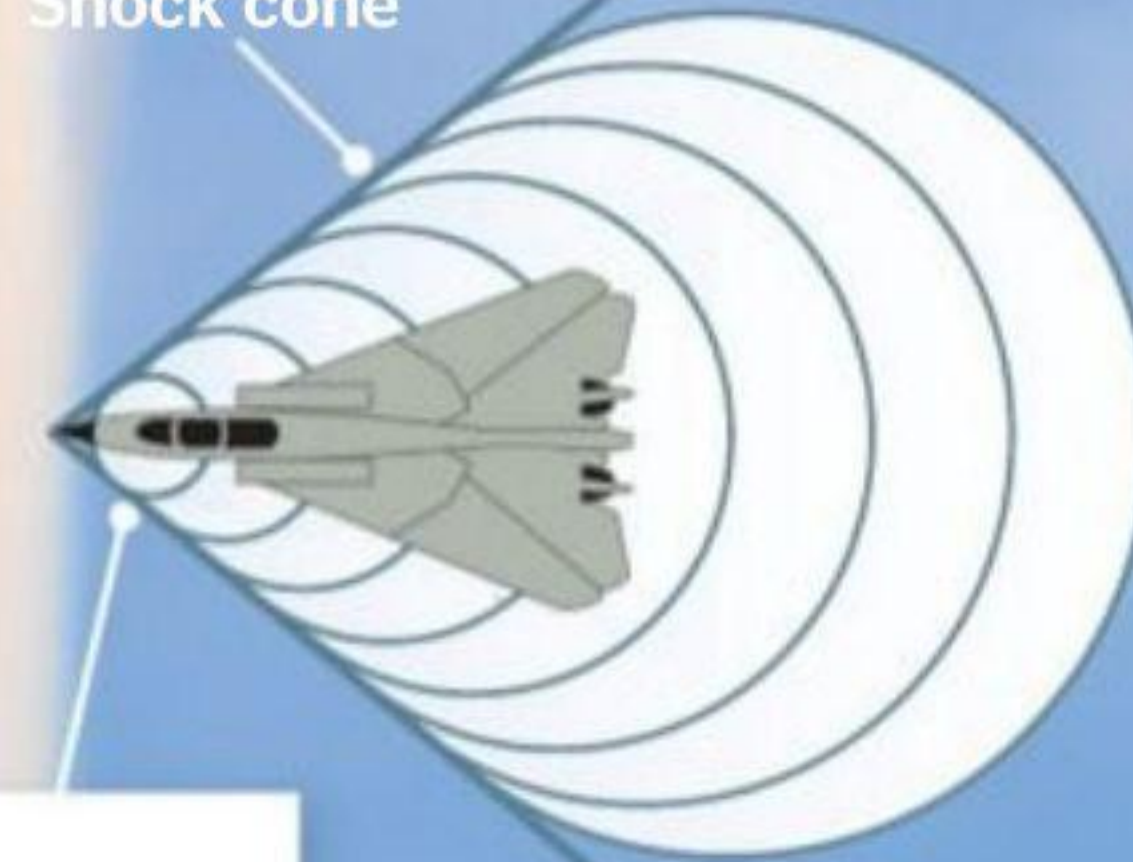

SUPERSONIC SPEED

Above Mach 1

As the plane exceeds the speed of sound, it overtakes the waves. This causes a change in air pressure, or a shock wave, which is heard as a sonic boom.



HOW IT WORKS

COMMERCIAL AIRCRAFT

Building a hypersonic vehicle

BUILDING A HYPERSONIC VEHICLE

The challenges and successes in the engineering community's quest for hypersonic flight

Supersonic aircraft such as Concorde differed greatly from their subsonic counterparts. They had adapted wing designs and advanced engines. These changes allowed Concorde to smash through the sound barrier, which is something subsonic commercial jets were simply unable to do.

The difference between a supersonic and a hypersonic aircraft is even more striking, because at hypersonic speeds the rules change completely. The previously benign air starts to become a serious problem, as aircraft moving at hypersonic speed generate huge amounts of friction. This results in temperatures hot enough to melt the frame of a standard jet, so hypersonic aircraft must be built from robust heat-resistant

materials such as ceramics. And they can't stop there, because even if they are able to withstand the heat, the pressure at low altitudes is simply too great to fly at hypersonic speeds. Hypersonic vehicles need to climb high up into the atmosphere, where the air is much thinner, in order to lessen the strain on the aircraft.

Perhaps the biggest consequence of the intense airflow is that hypersonic vehicles can't even use the same engines as subsonic aircraft. Air moving through supersonic plane engines does so at subsonic speeds (the supersonic airflow is slowed by an engine inlet), but if you tried using a similar setup when traveling at hypersonic speeds, it would melt or simply explode before your eyes. But rather than rely on

rocket engines—the only proven systems to power hypersonic vehicles—engineers asked themselves a more ambitious question: could we take what we've learned about the jet engine and design an equivalent that works at high supersonic, and even hypersonic, speeds?

This led to the invention of the supersonic combustible ramjet, or scramjet. Taking the principles of a jet engine and stripping away all of the unnecessary components for hypersonic travel—such as a turbine and a compressor—allows air to move through much more quickly. With few moving parts, these simple-looking engines produce enough thrust for an aircraft to soar at incredible speeds; and in doing so, have started to bring the future of air travel to life.

"At hypersonic speeds the rules change completely"

The scramjet

Meet the supersonic combusting scramjet, an engine that thrives at hypersonic speeds

'Air-breathing' engine

Unlike rockets, scramjets rely on air from the atmosphere to burn their fuel.

'Ramming'

Air is forcibly packed into the engine due to the immense speed of the aircraft.

Supersonic flow

Airflow is slightly slowed to increase temperature and pressure but still flows through the engine at supersonic speeds.

Speed

Scramjets are most efficient at hypersonic speeds starting from around Mach 6.

Supersonic airflow

An inlet conditions the airflow before delivering it to the engine, where heat is then added in order to generate the thrust needed.

Subsonic airflow

Air is drawn into the engine by turbines and compressed, slowing the flow to subsonic speeds.

Scramjet engine

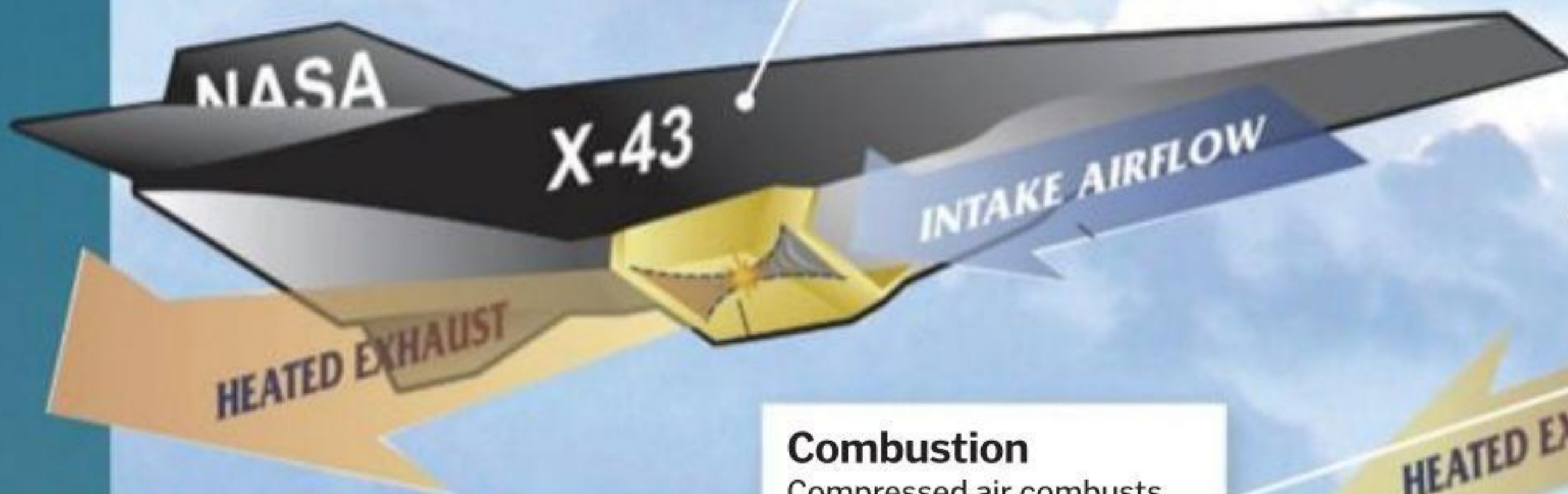

Combustion

Compressed air combusts the fuel source and leaves at a higher temperature and pressure through the exhaust, producing thrust.



Speed

Conventional jet engines are capable of operating at speeds of up to Mach 3.5.

Conventional jet engine

DID YOU KNOW? A hypersonic vehicle would experience 1,084,674lb/m² of pressure if flown at ground level

The Waverider's hypersonic design is partly incorporated into many of Boeing's hypersonic vehicles

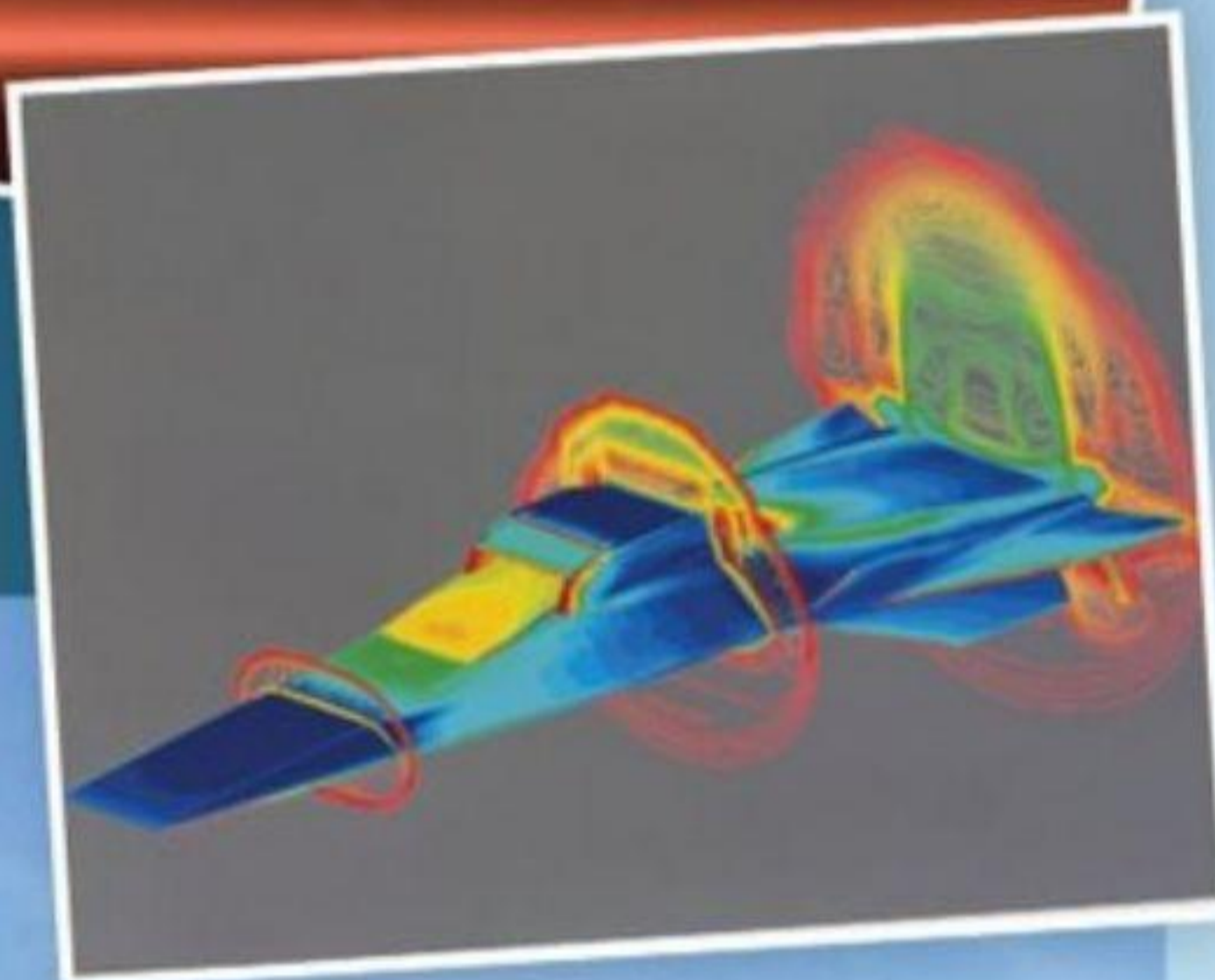
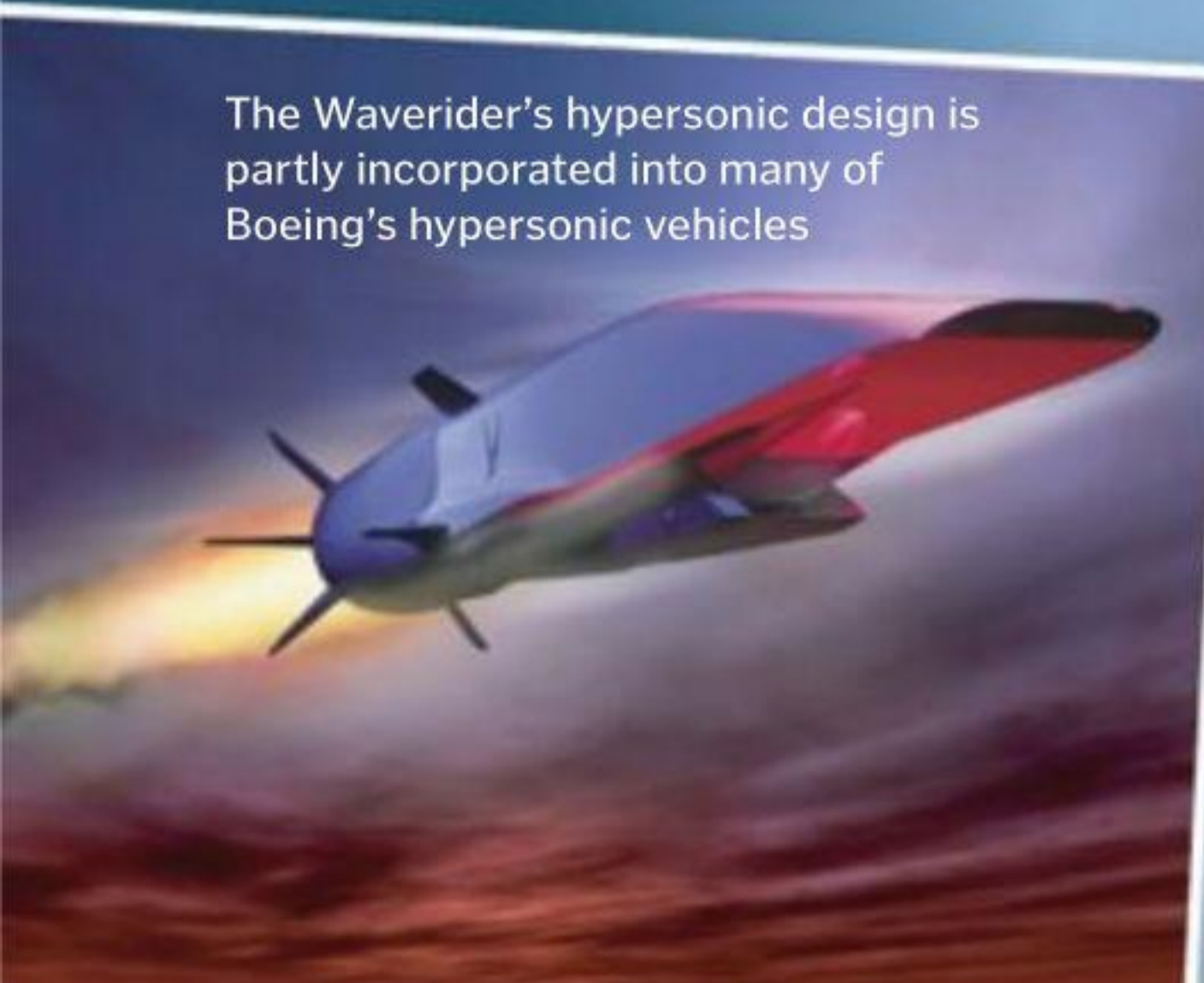

The X-43 was the first aircraft to travel at Mach 7, enduring 3,002°F in the process

Thrust

Pressurized air combusts the fuel source and produces thrust as it exits the engine.



MAKING HYPERSONIC FLIGHT A REALITY

We spoke with Boeing's chief scientist of hypersonics, Dr Kevin Bowcutt, about the future of high-speed travel



Dr Kevin Bowcutt is the senior technical fellow and chief scientist of hypersonics at Boeing. He is an AIAA Fellow, a Fellow of the Royal Aeronautical Society, and also a member of the National Academy of Engineering. He holds BS, MS and PhD degrees in aerospace engineering from the University of Maryland, USA.

Why is Boeing so interested in the hypersonic technology?

Boeing is interested in hypersonic technology for several reasons, including application to missiles, aircraft, and space planes. Hypersonic airplanes may someday whisk passengers and cargo across oceans in an hour or two, enabling international day trips. Perhaps most exciting of all, reusable hypersonic space planes may make transportation to Earth's orbit more like flying in an airplane than a rocket, and therefore much more affordable—up to 100- times cheaper.

What hypersonic technologies are you currently developing?

Key enablers to make hypersonic flight a reality include lighter and more durable high-temperature materials, increased hypersonic engine efficiency, and advanced sensing and data analysis technologies. On the technology front we are developing advanced high-temperature ceramic matrix composite materials, structures, and thermal protection systems. We are also developing, and have applied, advanced hypersonic vehicle design methods based on multidisciplinary design analysis and optimisation (MDAO). We have designed, and continue to study, hypersonic vehicle concepts such as missiles, reconnaissance aircraft, passenger airplanes, and reusable launch vehicles (space planes). We have built and successfully flown two scramjet-powered experimental vehicles, the NASA X-43A and the USAF/DARPA X-51A.

What are the main challenges that you currently face?

Finding materials that withstand very high temperature, and that are lightweight and

durable, remains a challenge, although good progress is being made in their development. Scaling up scramjets to larger sizes (beyond small jet engine size in terms of air flow rate) and speeds above Mach 7 is another difficulty due to ground testing limitations. Integrating low-speed and high-speed propulsion systems into combined cycle engines is another area for further development; combined cycle engines are required to accelerate from zero to hypersonic speed. Additional challenges include vehicle thermal management and thermo-structural health monitoring, as well as designing highly integrated systems such as hypersonic vehicles, driving the need for MDAO. On top of this, adequate funding is a perennial problem, although the situation is improving.

What is the overall goal of your project?

While Boeing is not developing a hypersonic airliner, and does not see a near-term demand for the product, we continue to research many advanced hypersonic concepts and technologies, so that we are prepared if the market develops for such vehicles. The potential for hypersonic aircraft in the future will require further advances in several areas of technology, as well as market demand. Ultimately, we want to help create the future of flight: ultra-rapid global transportation and routine and affordable space access.

How do you personally picture the future of hypersonic flight?

Although it's likely to be a few decades away, I envision a future where Mach 5 airplanes fly people between international cities in a couple of hours, and space planes routinely fly people to a hub in Earth's orbit for connecting flights to the Moon or Mars. Eventually, these vehicles will be powered by clean, high-density energy, probably some form of safe nuclear power.



HOW IT WORKS

COMMERCIAL AIRCRAFT

The future

THE FUTURE OF HYPERSONIC FLIGHT

Exploring the concepts that could one day replace the jet plane

If there's one lesson that we've learned about hypersonic flight so far, it's that heat, weight and power are all major obstacles. Too much weight, and you can't reach the desired speed. Too much heat, and your aircraft will melt mid-flight. And then there's the question of how we can power our machine to hypersonic speeds and keep it there. Fortunately, solutions for each of these critical problems have been suggested—and some seriously cool aircraft have been designed in the process.

Innovative engineers such as Charles Bombardier have been at the forefront of these endeavours. His envisioned aircraft, called Skreemr, would take to the skies with the help of an electrical launch system such as a railgun—so we could be bidding farewell to runways one day. A railgun is an electromagnetic strip that uses electricity to launch projectiles at incredible speeds, and one could be used to fire the Skreemr into the air. This would eliminate the need for tons of extra rocket fuel for take-off, thereby reducing the aircraft's weight considerably (as well as costs).

Another design by Bombardier, known as the Antipode, could tackle the heat problem as well as the menacing sonic boom. By using counter-flowing jets of air that move outwards in front of the aircraft, the temperature generated from aerodynamic friction and the sound produced by the sonic shock waves would be significantly reduced. And these features would help the Antipode fly up to Mach 24, equivalent to 18,330 miles per hour! These designs are still some time away from being realized, but Airbus and Reaction Engines have recently generated two concepts that could have us cruising at hypersonic speeds that much sooner.

Hypersonic hopefuls

Rival aerospace engineers are tackling the same mission in two very different ways

LAPCAT A2 REACTION ENGINES

ULTRA-RAPID AIR VEHICLE AIRBUS

Passengers

Up to 300 passengers plus baggage can be transported, ensuring ticket prices remain competitive with those of subsonic airliners.

Airframe

The shape of the aircraft allows the pilot to maintain control across the full Mach range.

Rocket booster

As the turbojet engines are retracted, a rocket engine pushes the plane beyond Mach 1.

Mounted ramjet engines

These engines generate thrust once the aircraft has reached a high altitude and is traveling at supersonic speeds.

Rotating fins

Fins at the rear of the plane can switch between horizontal and vertical orientations for increased stability and speed control.

Rising to new heights

Airbus' Ultra-Rapid Air Vehicle will cruise over twice as high as today's airliners

Take-off

Jet engines attached to the fuselage would be used for taxiing and take-off.

Climbing

Once the aircraft has reached the lower stratosphere, the rocket engine ignites.

Cruising

Advanced ramjet engines are ignited when the aircraft reaches an altitude of 22mi.

Accelerating

The aircraft breaks through the sound barrier while traveling vertically, causing the sonic boom to travel horizontally instead of towards the ground.

The history of hypersonic travel

It's been 60 years since a piloted vehicle first traveled faster than Mach 5, breaking the hypersonic barrier in a defining moment that showed the true possibility of space travel. The X-15 aircraft not only showed us that we could be carried at hypersonic speed, but taught us about how best to design, control and safely land a vehicle capable of achieving such a feat. The aircraft itself was essentially a rocket/plane hybrid, built to endure temperatures up to 1,292 degrees Fahrenheit and fly at an altitude of over 62 miles, while being blasted through the air by a rocket engine at the rear. Its achievements filled its creators with confidence that they could soon launch a vehicle into space at high speeds and bring it back into the atmosphere safely. Essentially, the X-15 played a role in putting humans on the Moon.

The legendary X-15 was the first vehicle to carry a pilot at hypersonic speeds

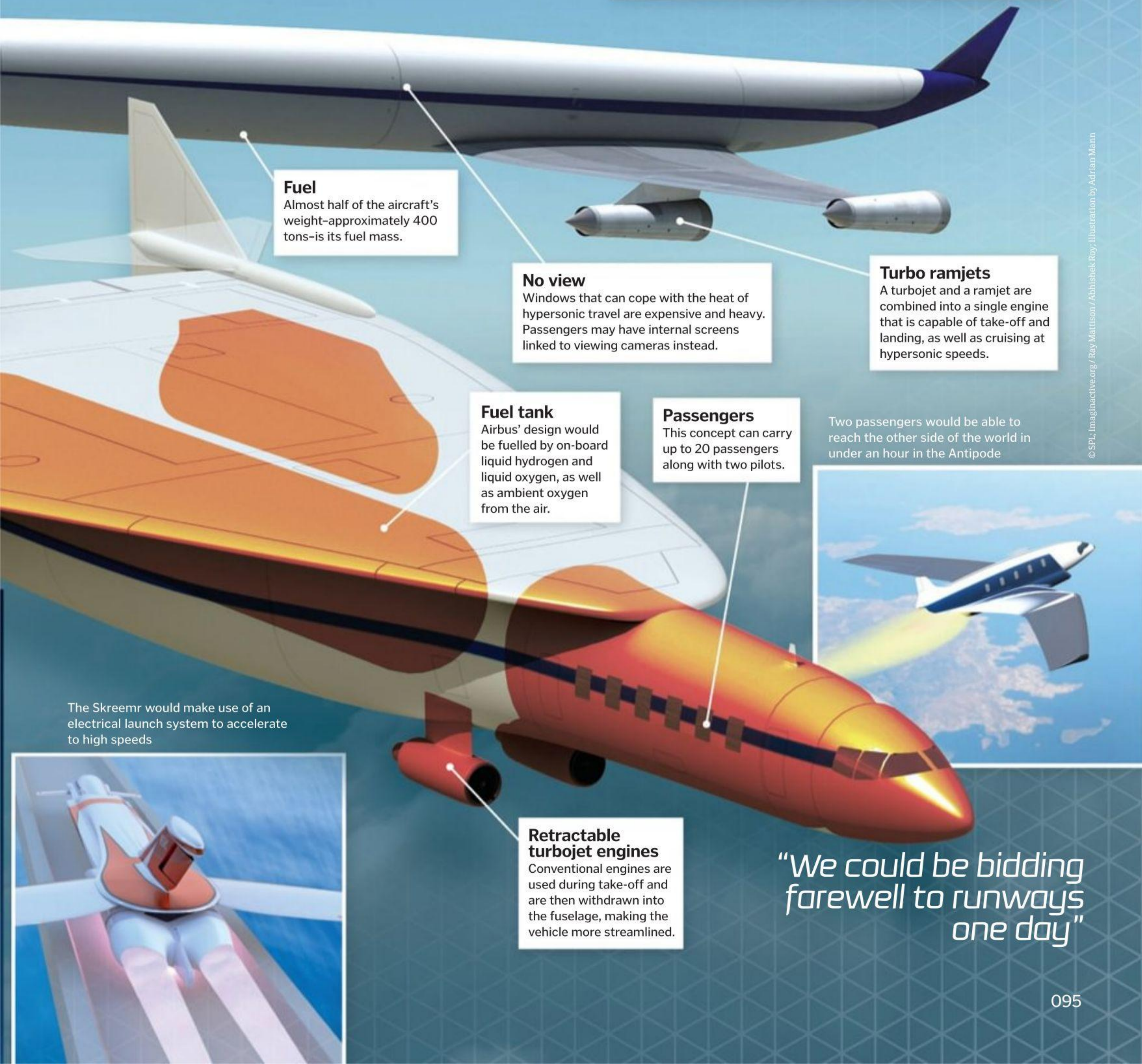

Fuel
Almost half of the aircraft's weight—approximately 400 tons—is its fuel mass.

No view
Windows that can cope with the heat of hypersonic travel are expensive and heavy. Passengers may have internal screens linked to viewing cameras instead.

Turbo ramjets
A turbojet and a ramjet are combined into a single engine that is capable of take-off and landing, as well as cruising at hypersonic speeds.

Fuel tank
Airbus' design would be fuelled by on-board liquid hydrogen and liquid oxygen, as well as ambient oxygen from the air.

Passengers
This concept can carry up to 20 passengers along with two pilots.

Two passengers would be able to reach the other side of the world in under an hour in the Antipode



The Skreemr would make use of an electrical launch system to accelerate to high speeds

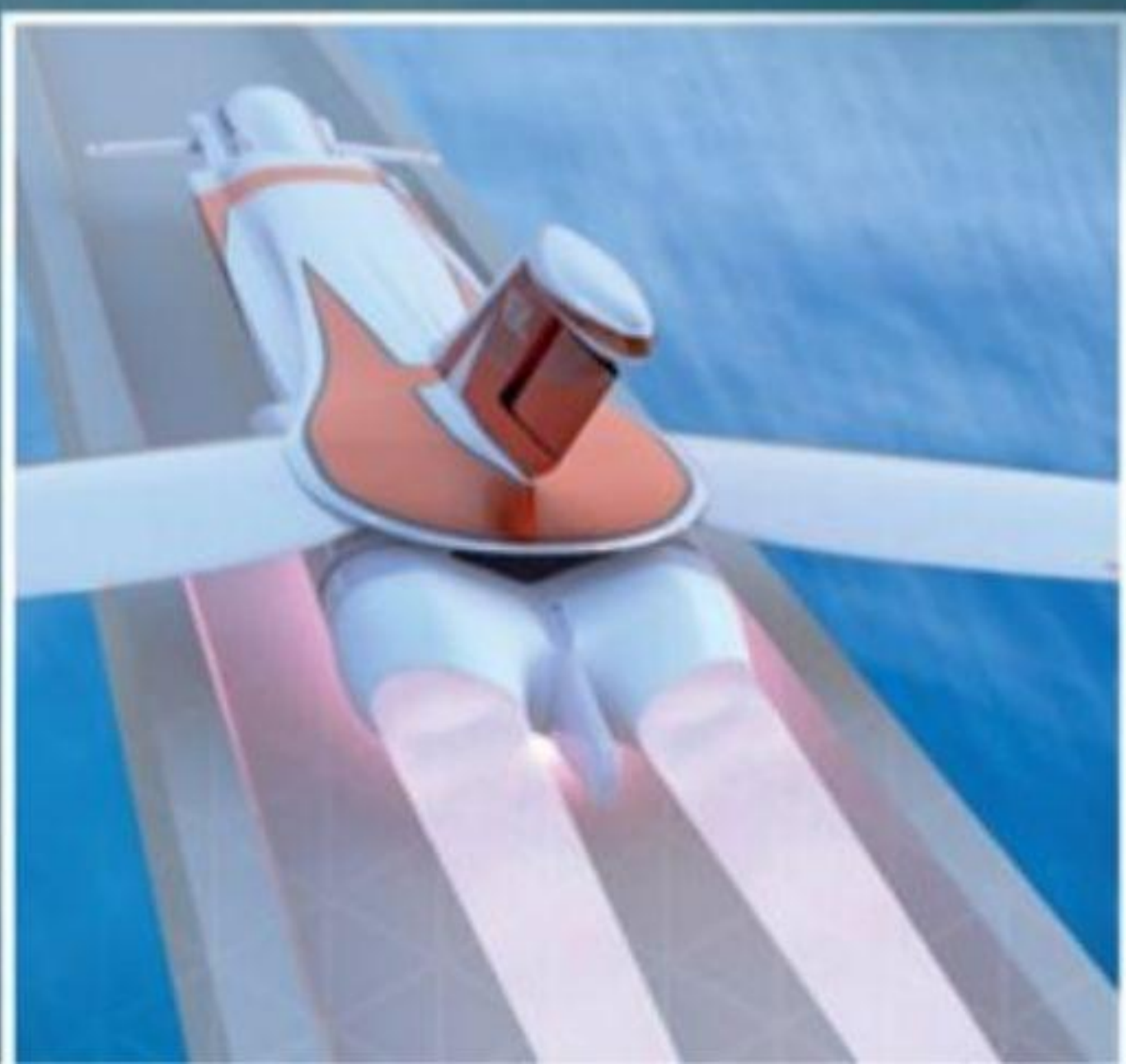

Retractable turbojet engines
Conventional engines are used during take-off and are then withdrawn into the fuselage, making the vehicle more streamlined.

"We could be bidding farewell to runways one day"



HOW IT WORKS

COMMERCIAL AIRCRAFT

Next-gen airships

HIGH-SPEED HOLIDAYS

It may soon be possible to watch the Sun rise in Paris and set in Tokyo

Most of us see traveling to the other side of the globe as the trip of a lifetime. Aside from the expense, these journeys take a very long time indeed. When we have to watch hours upon hours of in-flight entertainment on long-haul flights, it feels like we're lumbering through the air.

Ever since the world lost Concorde in 2003 we've been content to fly within the sound barrier. But the answer to our travel woes could be to punch right through it and go faster than any passenger plane has before. By flying at the upper limits of supersonic speed and into the hypersonic speed region, we could dramatically reduce travel times and change the way we explore the world.

The unique design of the aircraft has become the main challenge for revolutionizing air travel. Most passengers probably wouldn't be comfortable strapping into a rocket and blasting across the planet. Using a rocket for international travel would also be unfeasibly expensive, complicated and bad for the environment.

Ideally, the hypersonic passenger carrier of the future will operate much like today's subsonic airliners. Passengers would be able to take their seats in a pressurized cabin and the vehicle would be able to take-off and land unaided on a conventional runway.

Engineers have decided that using multiple engine types is the way to get this technology off the ground. Typical jet engines could be used for take-off and landing; a rocket engine could then propel us to great heights and speeds; and then the supersonic or hypersonic engine could take over. This would nevertheless be something of a thrill ride, as some designers believe their aircraft would have to take off near vertically!

Those of us with a nervous disposition to flying may find it best to stick to the relatively sluggish speeds of a jumbo jet. However, for those vacationers and businesspeople who want to maximize the time spent at their destinations and are willing to brave a vertical ascent into the atmosphere, hypersonic journeys will be the way forward.

Taking tourists to the upper stratosphere

Meet ZEHST, the Zero Emission High-Speed Transport of the future

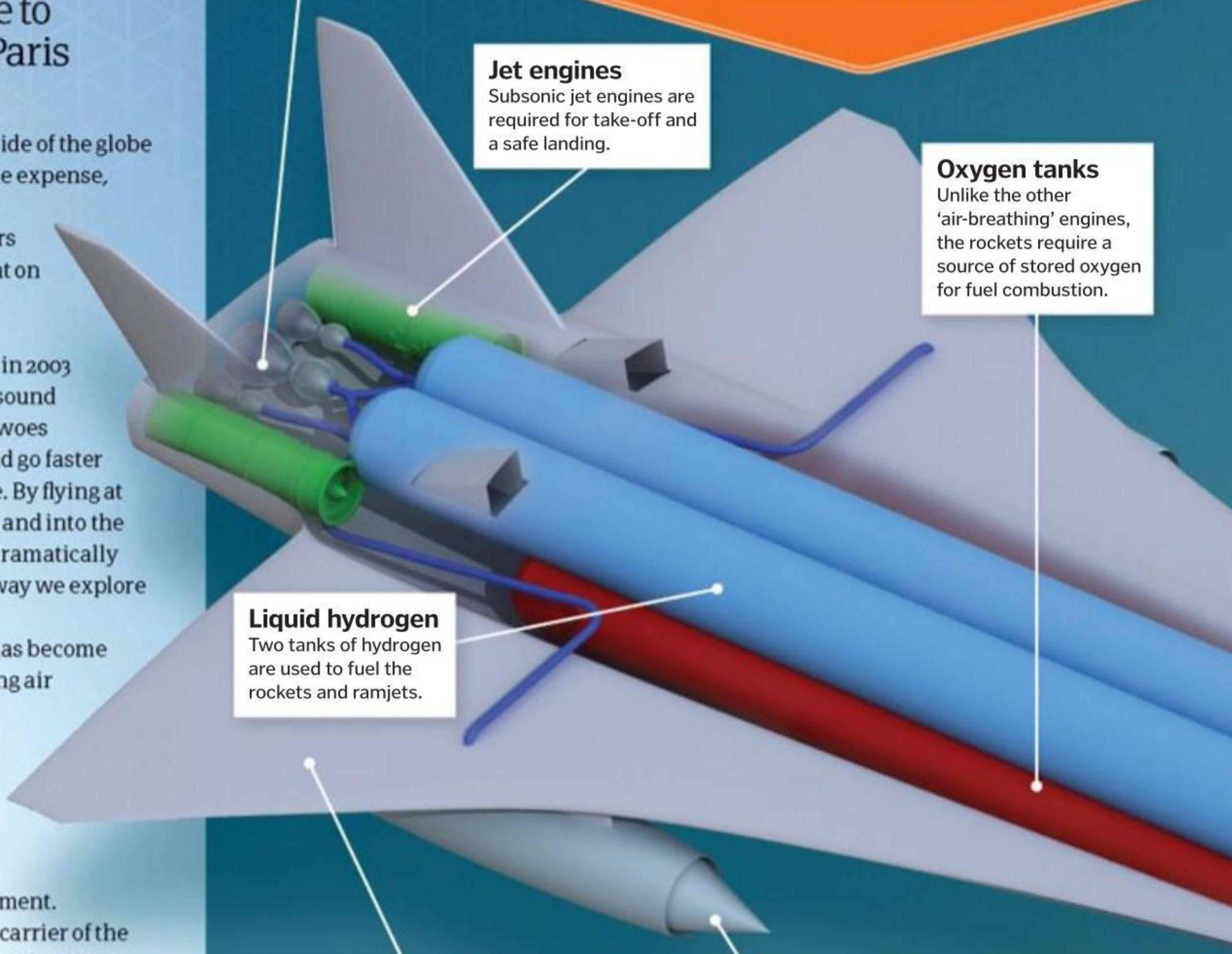

Rocket power
Rockets take over from the jet engines after take-off to increase the aircraft's speed to at least Mach 2.5.

Jet engines
Subsonic jet engines are required for take-off and a safe landing.

Oxygen tanks
Unlike the other 'air-breathing' engines, the rockets require a source of stored oxygen for fuel combustion.

Liquid hydrogen
Two tanks of hydrogen are used to fuel the rockets and ramjets.

Lightweight materials
To compensate for the weight of multiple engines, the frame must be lightweight yet strong enough to endure high levels of aerodynamic drag.

Ramjets
When the aircraft's speed reaches 1,926mph, air can be 'rammed' through the ramjets fast enough for the engines to produce thrust.

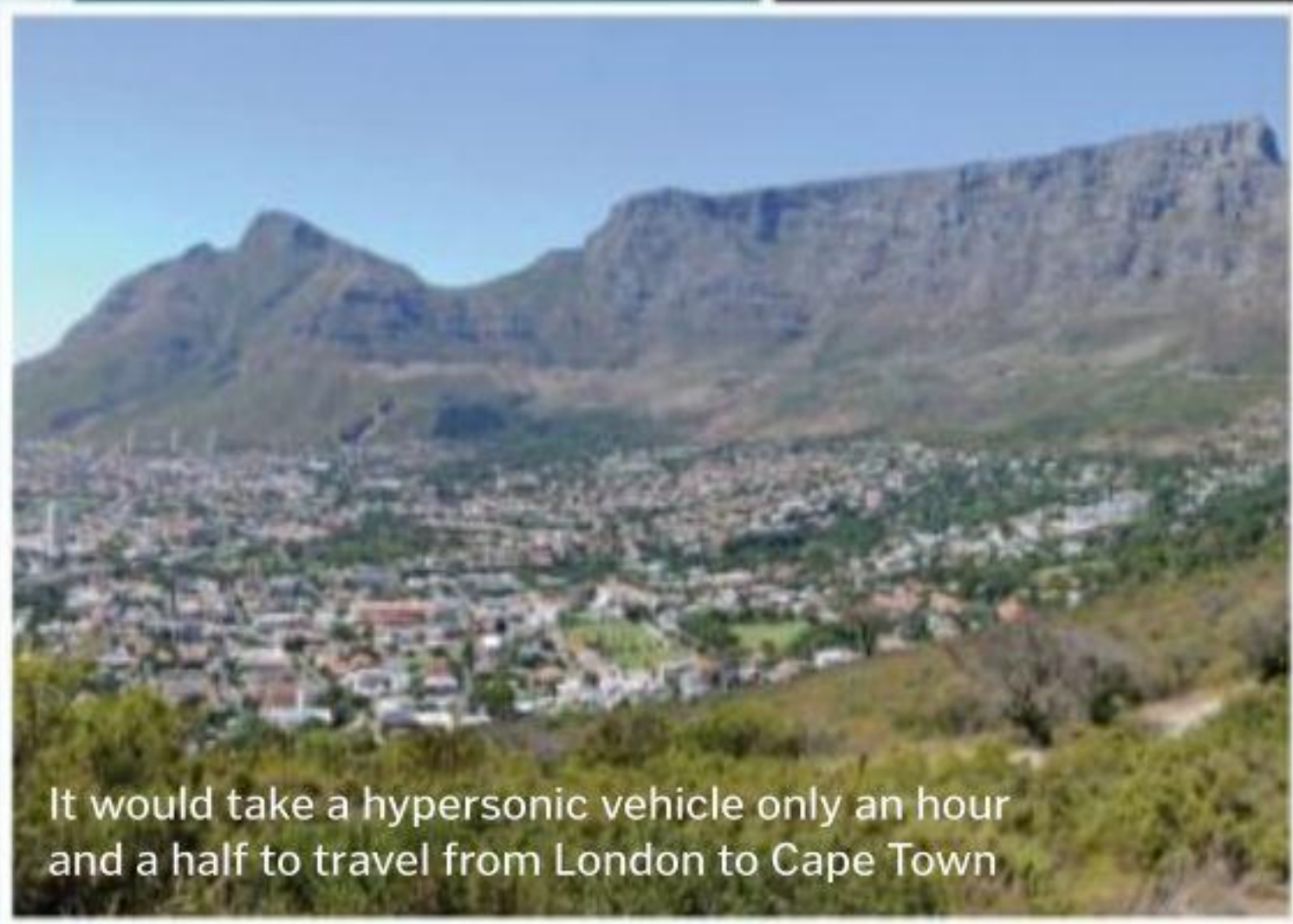

It would take a hypersonic vehicle only an hour and a half to travel from London to Cape Town

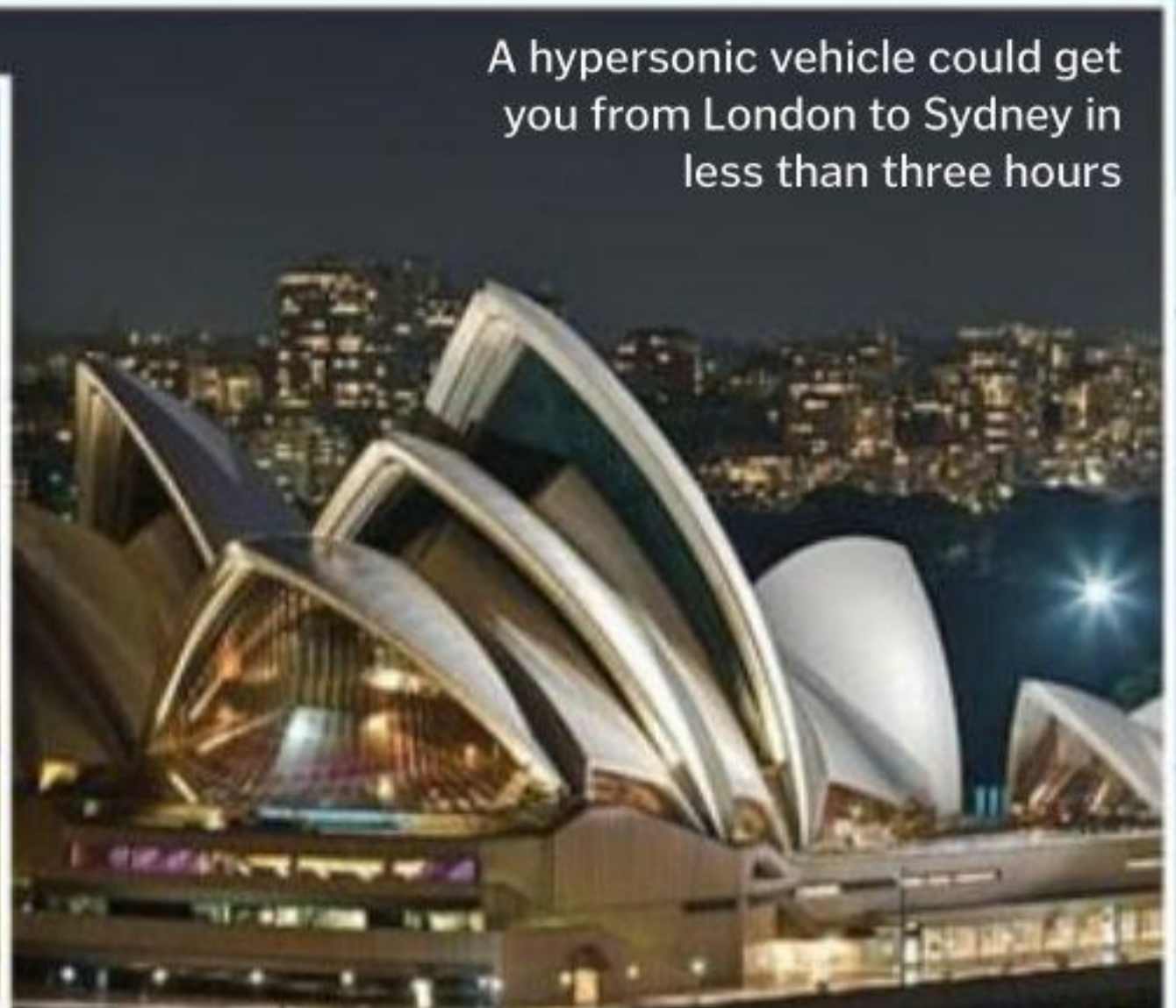

A hypersonic vehicle could get you from London to Sydney in less than three hours

Suppressing the sonic boom

Whether you're going supersonic or hypersonic, breaking the sound barrier is loud. As a vehicle accelerates, the waves of air pressure being pushed along by the frame begin to merge into one single shock wave. This air can travel at the speed of sound but as a vehicle surpasses this speed, a drastic change in pressure results in a deafening clap—a sonic boom.

The sonic boom is one major hurdle for aviation companies to overcome if hypersonic flight is going to be made available commercially. Concorde—the first and only public transport to break the sound barrier—was criticized for its volume and was only permitted to break the sound barrier over the ocean.

Like many aerospace issues, it could be NASA that comes to the rescue once again. The space agency and its partners at Lockheed Martin are in the process of designing an aircraft with many lifting surfaces to stop the airwaves from combining. The result would be a series of small booms rather than one big one—lowering the sound output to that of a normal conversation.



NASA and Lockheed Martin's Quiet Supersonic Technology (QueSST) X-plane design will be a step towards 'low-boom' supersonic travel

"Hypersonic travel would change the way we explore the world"

Helium tanks

Helium is used to pressurize the propellant tanks, allowing liquid hydrogen to be combusted in the rocket engines.

Passenger cabin

Up to 100 passengers can be carried in the pressurized cabin.

High altitude

To minimize air resistance the ZEHST would climb 20mi above sea level for its journey—three-times higher than a Boeing 747!

Streamlined design

The pointed nose and narrow wingspan, reminiscent of Concorde, maximize the aerodynamics of the vehicle.

Goodbye long-haul flights

Domestic hypersonic travel promises to make the world feel a whole lot smaller

1 hr
NEW YORK

ZEHST

Concorde

Boeing 787

LONDON

London to New York flight times

1hr	ZEHST 3,840mph (Mach 5)
3.5hrs	Concorde 1,355mph (Mach 2)
8hrs	Boeing 787 572mph (Mach 0.85)

BOOK OF
AIRCRAFT

FUTURE PLC

Future PLC Quay House, The Ambury, Bath, BA1 1UA

Editorial

Editor **Charles Ginger**

Designer **Steve Dacombe**

Senior Art Editor **Stephen Williams**

Head of Art & Design **Greg Whitaker**

Editorial Director **Jon White**

Cover & All Photography images

Dr. Stefan Petersen, Delair Aerial Intelligence, Thinkstock
All copyrights and trademarks are recognised and respected

All information was correct at the time of printing

All contents © 2024 Future Publishing Limited
or published under licence.

A360 MEDIA

President & Chief Media Officer
Doug Olson

Executive Vice President
Eric Szegda (Consumer Revenue)

Vice Presidents
Holly Oakes (Consumer Marketing)
Tom Maloney (Consumer Marketing & Sales)

Consumer Marketing Director
Melanie Pisell

Circulation Manager
Bill Fiakos

Published by A360 Media.

All rights reserved. Reproduction in whole or in part without written
permission of the publisher is prohibited.

Printed in the U.S.A.

Magazine SHOP

Your One Stop Single Copy Shop.



Or go to:
www.magazineshop.us/emiril

FREE SHIPPING
on all U.S. orders

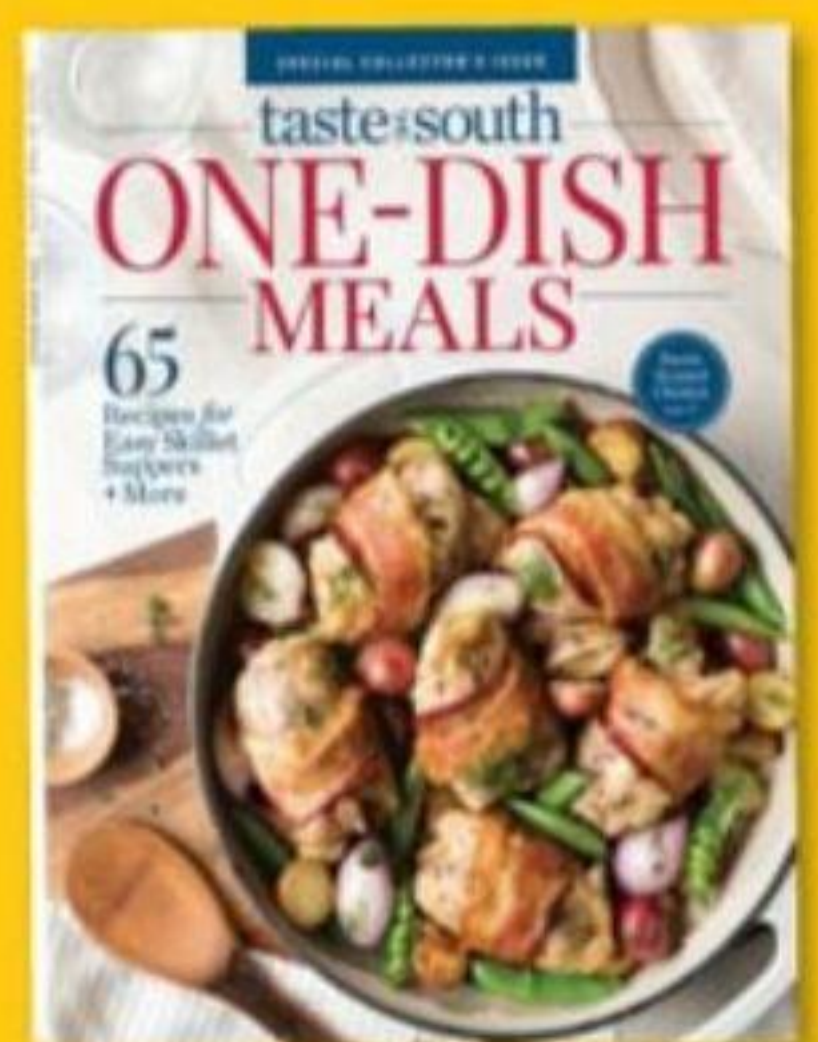
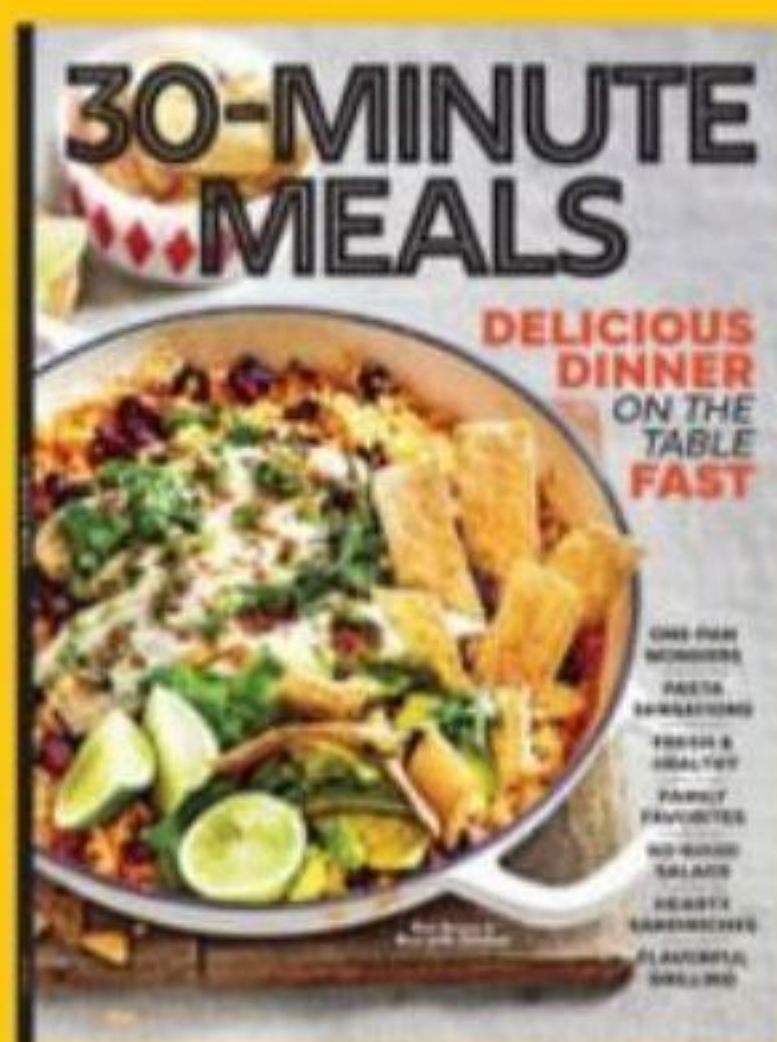

Find these magazines and many more online!